



XRS-370C Quick Start Guide

Compact Hideaway 80 Channel UHF CB Radio

The full Instruction Manual can be downloaded from www.gme.net.au

In the box

- XRS-370C 5 watt UHF CB radio
- Mounting cradle (MB009)
- XRS Connect speaker microphone (MC664B)
- Microphone extension lead (LE040)
- 8 pin to 8 pin adaptor (AD008)
- Microphone clip (MB206)
- DC lead (LE09)
- Screw pack
- Quick start guide

Introduction

Your GME XRS-370C 80-channel CB radio is designed and manufactured in Australia and is the most advanced UHF Citizen Band radio available. It combines the very latest in electronic hardware and software to produce an extremely compact mobile radio with innovative features and outstanding specifications and performance. The XRS Connect speaker microphone with OLED display and front mounted speaker provides clear sound and total control from the palm of your hand. XRS Connect are the first UHF radios with an app to configure and control the radio. Visit gme.net.au/GETXRS for more information.

IMPORTANT INFORMATION CONCERNING UHF CB RADIO

The use of the Citizen Band radio service is licensed in Australia by the Australian Communications and Media Authority (ACMA) Radio communications (Citizens Band Radio Station Class Licence and in New Zealand by the Ministry of Economic Development New Zealand (MED)).

A General User Radio Licence for Citizens Band radio and operation is subject to conditions contained in those licences.

The class licence for users and equipment operating in the CB/PRS 477 MHz band was amended in 2011 to include 80 channels. This radio meets the 80 channel standard.

Further information and updates are available from the ACMA at www.acma.gov.au and the MED, Radio Spectrum Management at: www.rsm.govt.nz

Emergency channels

The ACMA has allocated channels 5/35 for emergency use only. Channel 5 is the primary Simplex Emergency Channel. Where a Channel 5 repeater is available, you should select Duplex on CH 5.

NOTE: Channel 35 is the input channel for the Channel 5 repeater therefore Channel 35 should also not be used for anything other than emergency transmissions.

Telemetry Channels

ACMA regulations have allocated channels 22 and 23 for telemetry only applications and have prohibited the transmission of speech on these channels. Consequently your radio has a transmit-inhibit applied to channels 22 and 23. Currently transmissions on channels 61, 62 and 63 are also inhibited and these channels are reserved for future use.

GENERAL OPERATION

Controls

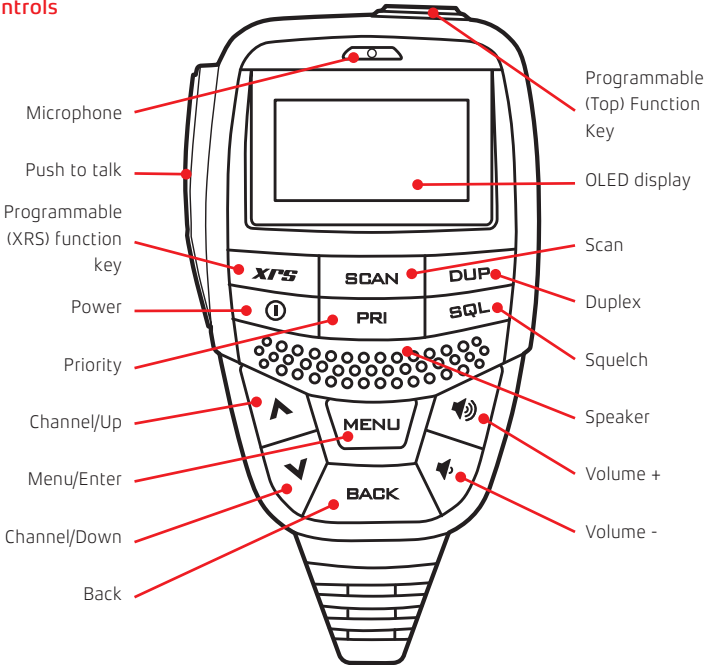

Summary of basic controls

For a detailed description please refer to the full instruction manual available from the GME website.



Receiving

Power:	Press and hold the i key to turn the radio on or off.
Volume:	Press the ↗ or ↖ keys to adjust the volume.
Selecting Channels:	Press the ▲ or ▼ keys to select a channel.



Squelch:	Press the SQL key to open or close the squelch.
Duplex Mode:	To enable or disable Duplex on a repeater channel, select the required repeater channel (1 - 8, 41 - 48) then press the DUP key. The  icon will appear whenever Duplex is enabled on the current channel.
Priority Channel:	To store a Priority channel, select the required channel then hold the PRI key. To recall a Priority channel press the PRI key. The 'PRI' icon is displayed whenever the Priority channel is selected.



Transmitting

IMPORTANT: Always listen to ensure the channel is free before transmitting.

To transmit, press the **PTT** on the microphone. The  icon will appear. Hold the microphone about 3-5 cm from your face and speak at a normal voice level. Release the **PTT** when you have finished talking, the  icon will disappear.

Menu

The Menu provides access to all the settings, adjustments and functions in the radio. All menu items are controlled using the **MENU**, ,  and **BACK** keys.

To access the menu, press the **MENU** key. Scroll through the list of menu items using the  or  keys. To select an item, press the **MENU** key. To step back through the menu, or to exit the current screen, hold the **BACK** key.

MAIN WIRING AND CONNECTION

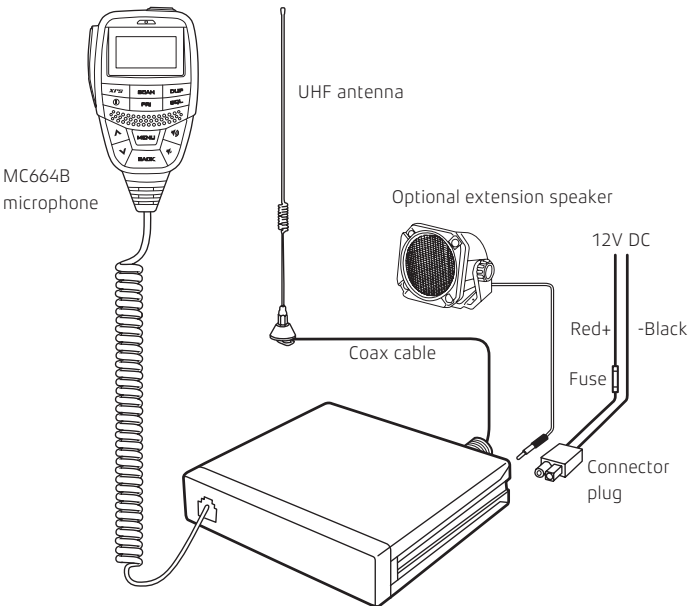

Antenna connection

It is essential to select a good quality, high efficiency, 477 MHz antenna. A poor quality antenna or one not designed for the specific frequency band you are using will give very poor performance.

Connect to the antenna cable to the rear antenna socket using a PL259 coaxial connector.

INSTALLATION

Mounting option 1

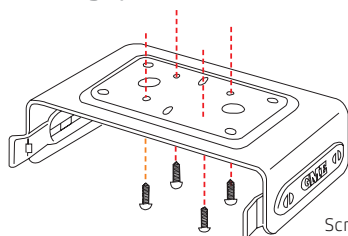

Mounting option 2

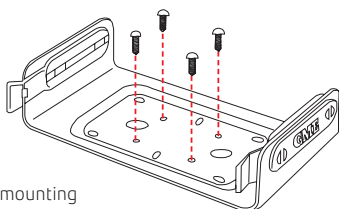

Screw mounting cradle to a firm surface.

Inserting the radio

Slide radio fully into cradle until it clicks into place.

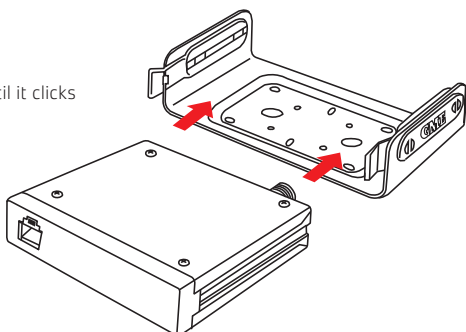

Inserting the microphone

Plug the microphone's 8 pin plug into the socket on the front of the main unit.



Removing the radio

Gently spread tabs

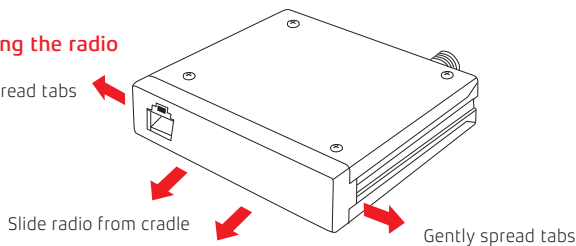

Slide radio from cradle

Gently spread tabs

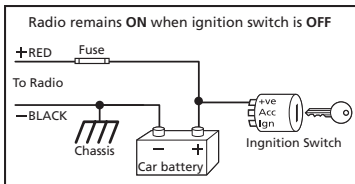
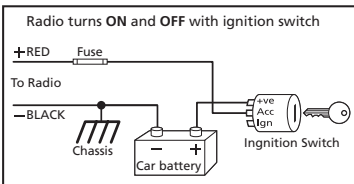
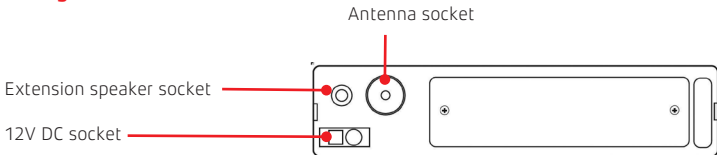

Wiring



XRS Connect app

The GME XRS Connect app is the easy way to customise, update and maintain your XRS Connect radio. To download the free XRS Connect app for iOS or Android go to the App Store or Google Play and search for 'XRS Connect'. Download and register the XRS Connect app and receive an additional one year warranty – available for a limited time.

Pairing

To pair your Smart Device with your XRS Connect radio, open the XRS Connect app, go to the 'My Radio' tab and select 'Connections'. Locate your radio in the list and select 'Pair'. Once connected, your app will return to the 'My Radio' screen and the  icon on your radio should change to  to show that the **Bluetooth** pairing is successful. Once connected select the 'Read from Radio' button to read your radio's settings into the app. After you have configured your preferences in the app, select 'Write to Radio' to update your radio with your new settings.

NOTE: The **Bluetooth**® connection between your smart device and your XRS Connect radio must be made through the XRS Connect app. You will not be able to pair your smart device to your XRS Connect radio using the normal **Bluetooth** settings option on your smart device.

XRS Connect radios are compatible with iOS 9.0 and above and Android 5.0 and above. A full list of compatible devices and application software is available at gme.net.au/GETXRS

Standard Communications Warranty against Defects

This warranty against defects is given by Standard Communications Pty Ltd ACN 000 346 814 (We, us, our or GME). Our contact details are set out in clause 2.7.

1. Consumer guarantees

1.1 Our goods come with guarantees that cannot be excluded under the Australian Consumer Law. You are entitled to a replacement or refund for a major failure and for compensation for any other reasonably foreseeable loss or damage. You are also entitled to have the goods repaired or replaced if the goods fail to be of acceptable quality and the failure does not amount to a major failure.

1.2 To the extent we are able, we exclude all other conditions, warranties and obligations which would otherwise be implied.

2. Warranty against defects

2.1 This warranty is in addition to and does not limit, exclude or restrict your rights under the Competition and Consumer Act 2010 (Australia).

or any other mandatory protection laws that may apply.

2.2 We warrant our goods to be free from defects in materials and workmanship for the warranty period (see warranty table) from the date of original sale (or another period we agree to in writing). Subject to our obligations under clause 1.2, we will at our option, either repair or replace goods which we are satisfied are defective. We warrant any replacement parts for the remainder of the period of warranty for the goods into which they are incorporated.

2.3 To the extent permitted by law, our sole liability for breach of a condition, warranty or other obligation implied by law is limited

(a) in the case of goods we supply, to any one of the following as we decide –

- the replacement of the goods or the supply of equivalent goods;
- the repair of the goods;
- the cost of repairing the goods or of acquiring equivalent goods;

(b) in the case of services we supply, to any one of the following as we decide –

- the supplying of the services again;
- the cost of having the services supplied again.

2.4 For repairs outside the warranty period, we warrant our repairs to be free from defects in materials and workmanship for three months from the date of the original repair. We agree to re-repair or replace (at our option) any materials or workmanship which we are satisfied are defective.

2.5 We warrant that we will perform services with reasonable care and skill and agree to investigate any complaint regarding our services made in good faith. If we are satisfied that the complaint is justified, and as our sole liability to you under this warranty (to the extent permitted at law), we agree to supply those services again at no extra charge to you.

2.6 To make a warranty claim you must before the end of the applicable warranty period (see warranty table), at your own cost, return the goods you allege are defective, provide written details of the defect, and give us an original or copy of the sales invoice or some other evidence showing details of the transaction.

2.7 Send your claim to:

Standard Communications Pty Ltd.
PO Box 96 Winston Hills, NSW 2153, Australia.
Tel: (02) 8867 6000 Fax: (02) 8867 6199
Email: servadmin@gme.net.au

2.8 If we determine that your goods are defective, we will pay for the cost of returning the repaired or replaced goods to you, and reimburse you for your reasonable expenses of sending your warranty claim to us.

3. What this warranty does not cover

3.1 This warranty will not apply in relation to:

- goods modified or altered in any way;
- defects and damage caused by use with non Standard Communications products;
- repairs performed other than by our authorised representative;
- defects or damage resulting from misuse, accident, impact or neglect;
- goods improperly installed or used in a manner contrary to the relevant instruction manual; or
- goods where the serial number has been removed or made illegible.

4. Warranty period

4.1 We provide the following warranty on GME products. No repair or replacement during the warranty period will renew or extend the warranty period past the period from original date of purchase.

PRODUCT TYPE	WARRANTY PERIOD
477 MHz UHF CB mobile radios	5 years





Requires **Bluetooth® 2.1** (Android 5.0 or later) or **Bluetooth® 4.0** (iOS 9.0 or later).

The *Bluetooth®* word mark and logos are registered trademarks owned by the Bluetooth SIG, Inc. and any use of such marks by GME is under license. Other trademarks and trade names are those of their respective owners.

Apple and the Apple logo are trademarks of Apple Inc., registered in the U.S. and other countries. App Store is a service mark of Apple Inc.

Google Play and the Google Play logo are trademarks of Google Inc.

 **1300 463 463**  **gme.net.au**

A division of Standard Communications Pty Ltd.
Head Office: PO Box 96, Winston Hills, NSW 2153,
Australia. New Zealand: PO Box 58446 Botany, Auckland, 2163, NZ. T: (09) 274 0955.
All international enquiries email: export@gme.net.au

Find us on 