

GME **Electrophone:::** **INSTRUCTION MANUAL**

MODEL GX558



**VHF MARINE
TRANSCEIVER**

PN 310030
ISSUE 2

**STANDARD COMMUNICATIONS
PTY. LTD.**

WRITE YOUR GX558 IDENTIFICATION DETAILS HERE.

SERIAL NO. _____

OTC REG. NO. _____

(Aust. Version)

CONTENTS.	PAGE NO.
INTRODUCTION	3
FEATURES	4-5
SPECIFICATIONS	6-7
CONTROLS & FUNCTIONS	8-12
INSTALLATION	13-18
ANTENNA INSTALLATION	19-20
OPERATING YOUR GX558	21-35
OPERATING ON THE VHF MARINE BAND	36-37
EMERGENCIES	37
CHANNEL FREQUENCIES	38-39
WARRANTY	40

UNPACKING YOUR GX558.

Upon unpacking your GX558, please check the contents against this list.

- * GX558 VHF Transceiver * Mounting Bracket & Screws * Flush Mounting Kit (Aust. Version) * Microphone * Microphone Bracket & Screws
- * DC Power Lead * Spare Fuses (Attached to radio) * Instruction Book
- * Waterproof Operator's Chart * OTC Seaphone Registration Form. (Aust. Version)

NOTE: If any items are missing or damaged, contact the place of purchase immediately.

INTRODUCTION

Congratulations, you have just purchased one of the most technically advanced VHF Marine Transceivers available in the world.

The GME Electrophone GX558 is a VHF FM transceiver designed to operate in the 156-163 MHz marine band, and contains built-in features that, on some radios, aren't even available as options.

For example, the GX558 has *OTC DIRECT DIALLING built right in and supplied as standard. This means you can make telephone calls from your vessel by dialling directly into the telephone network via the keypad on your radio. All you need to do is register your radio's security number with OTC (so that you can be charged for your calls) and you can dial the world.

Then there are the safety features, including automatic selection of high transmit power when changing channels or modes, to ensure you always have the maximum chance to "get through" in an emergency, and the programmable scanning memory and dual watch functions, keeping you informed of all safety broadcasts and messages for your vessel at all times.

In addition, there is the optional remote station which allows you to have complete and independent control of all functions available on the front panel, from a separate location. It's the perfect addition to install in your flybridge or cabin, complete with intercom to allow on board communications between it and the main unit.

The GX558 is totally designed and manufactured in Australia at our Gladesville factory. Consistently high manufacturing quality is achieved by using precision robots to install the surface mounted components. The result is an advanced communications system of extreme reliability and performance.

Please read this manual thoroughly before using your GX558 to ensure you get the best performance from the advanced features. A waterproof Quick Reference Chart is provided with this manual and we recommend you keep this with your radio at all times.

***IMPORTANT NOTE.**

Your GX558, as supplied, is suitable for marine use in and around Australia and New Zealand. However, as OTC Auto Seaphone Direct Dialling is not currently available in New Zealand, radios distributed in New Zealand have been fitted with the international weather channels **INSTEAD** of the Auto Dialling feature.

If a compatible Auto Dialling System becomes available in New Zealand, your GX558 can be retrofitted with this feature, if required.

FEATURES

- * **Built in OTC DIRECT DIALLING with last number redial:** Make telephone calls to anywhere in the world from your vessel.
- * **All Channel Memory Storage:** Enough room to programme all available channels into the memory for later scanning.
- * **Full Memory Scanning with Skip and Hold:** Lets you scan all channels stored in the memory, with control over holding on to, or skipping over, busy channels.
- * **Permanent Memory:** Once programmed, the memory will retain its information indefinitely, until cleared on your command. No backup batteries or memory wire connections are necessary.
- * **Instant Channel 16 Emergency Override:** Allows you to go immediately to Channel 16 in an emergency (or otherwise) with ONE keypress, and cancels whatever mode you may have been in.
- * **Dual Watch Function with Channel 16 Priority:** Lets you operate on any selected channel while continuing to monitor Channel 16. Signals appearing on Channel 16 take priority over those on your selected channel.
- * **Soft Touch Keypad:** Allows quick and easy selection of all channels and functions.
- * **High/Low Transmit Power:** Push button selection of 25 watts or 1 watt output power, with automatic selection of high power when changing channels or modes.
- * **Fully Splashproof Keypad:** The flat panel keypad is fully sealed against moisture, giving total control over all functions while retaining the splashproof properties necessary for reliable marine operations.
- * **Frequency Update Option:** Your GX558 can easily be updated with any additional frequencies which may be approved at a later date.
- * **Optional Remote Station:** A plug-in remote station can be connected to allow your GX558 to be operated from two separate locations on board your vessel. (Requires an interface board and socket to be fitted by a technician).
- * **International and Australian Channels:** Allows operation both within Australian and New Zealand waters, and beyond into international waters.

- * **Liquid Crystal Display:** Indicates your operating channel and which functions are selected. Easily read, even in full sunlight, and has a light for night viewing.
- * **Panel Lighting in 3 Levels:** Internal lighting illuminates both the LCD panel and the keyboard for night viewing. Adjustable in three levels - OFF, DIM, BRIGHT.
- * **Flush Mounting Kit:** This kit is designed to facilitate a strong panel or bulkhead installation using our unique clamping method.
- * **Rubber Case Seals:** All case joins are sealed against the ingress of water to minimise the risk of internal corrosion should your radio be accidentally splashed or exposed to spray.
- * **Microprocessor controlled:** All functions are programmed into your GX558 for versatility, giving you more features at no extra cost.
- * **Intercom Feature between Remote Unit and Main Unit:** Allows both units to communicate on-board at any time.
- * **Channel 87A:** Your GX558 is fitted with the Australian Yachting Federation Channel 87A.
- * **Powerful 55mm Front Mounted Waterproof Speaker:** Projects the sound forward for greater clarity and less distortion.

SPECIFICATIONS

GENERAL

Frequency Range (DOC 274B)	: Receive = 156.30 to 162.025 MHz : Transmit = 156.025 to 157.425 MHz.
No. of Channels	: All 55 International Channels plus AYF87A.
Frequency Control Method	: Single Loop PLL Synthesiser.
Supply Voltage	: 11.0 to 15.2 Volts DC.
Rated Voltage	: 13.8 Volts DC.
Antenna Impedance	: 50 ohms.
Frequency Stability	: ± 5 PPM
Operating Temperature Range	: -10 deg C to +65 deg C
Channel Display	: LCD Numerical Readout
Speaker	: 55mm Round Front Mounted, 8 ohms water resistant polypropylene.
Microphone	: 600 ohm Dynamic with Skip/Hold Switch
Dimensions	: 115mm (D) x 200mm (W) x 65mm (H)
Weight	: 950g.
Controls	: ON-OFF/Volume, Squelch, Keypad Channel Selector, CH16 Recall Key, Dual Watch Key, 1W/25W Power Selector, Memory Key, Scan Key, OTC Auto Dialler Key (Aust. Version), Weather Channels Key (NZ Version).
Lights & Indicators	: LCD Channel Display, Scan, Dual Watch, Transmit, MEM, Hi Lo Power, Int. Channels, OTC Mode (Aust. Version), WX Channels (NZ Version), Orange Backlight.
Connectors	: Antenna, Microphone, External Speaker (3.5 mm), DC Power.
Standard Accessories	: Plug-in Microphone, Mounting Bracket and Hardware, DC Power Lead, 2 Spare Fuses, Instruction Manual.

RECEIVER.

Circuit System	: Double Conversion Superheterodyne
IF Frequencies	: 1st = 21.4 MHz : 2nd = 455 KHz
Sensitivity	: 0.3uV for 12dB Sinad (Typically 0.28uV) : 0.5uv for 20dB Quieting

Selectivity	: -6dB @ ± 7.5 KHz : Better than -75dB @ ± 25 KHz
Spurious Response Att.	: -75dB Typical
Image Response Att.	: -75dB Typical
Intermod. Rejection	: -70dB Typical
Blocking Rejection	: -90dB Typical
Squelch Range	: Threshold = 0.15uV : Tight = 0.6uV
Audio Output Power	: 3.0 Watts @ 10% THD into 8 ohms
Ext. Speaker Imp.	: 8 to 16 ohms
Audio Frequency Response	: -6dB per Octave within +1dB and -3dB
Hum & Noise Att.	: -55dB
Current	: Standby = 450mA : Full Audio = 700mA
Scan Rate	: 5 Channels/Sec. (0.2 Seconds / Channel) : Pause = 5 Seconds
Dual Watch	: 2 Channels / 2 Seconds : Pause = 5 Seconds

TRANSMIT.

Power Output	: 25 Watts/ 1 Watt (Switchable)
Current @ 13.8 Volts	: 4.5 Amps @ 25 Watts : 1.5 Amps @ 1 Watt
Modulation	: FM, ± 5 KHz Deviation (+20dB Limiting @ 1 KHz)
Frequency Response	: 6dB per Octave within +1dB and -3dB
Hum & Noise Att.	: -45dB
Modulation Distortion	: Less than 3% @ ± 3 KHz Deviation @ 1KHz
Microphone Sensitivity	: 70% Maximum Deviation @ 1 Pascal
Spurious Emissions	: Better than -70dBc
Output Power	
Stabilisation	: Built-in Automatic Level Control
Fuse Rating	: 10 Amp 30mm/32mm (3AG Type)

SPECIFICATIONS SUBJECT TO CHANGE WITHOUT NOTICE OR OBLIGATION

CONTROLS AND FUNCTIONS.

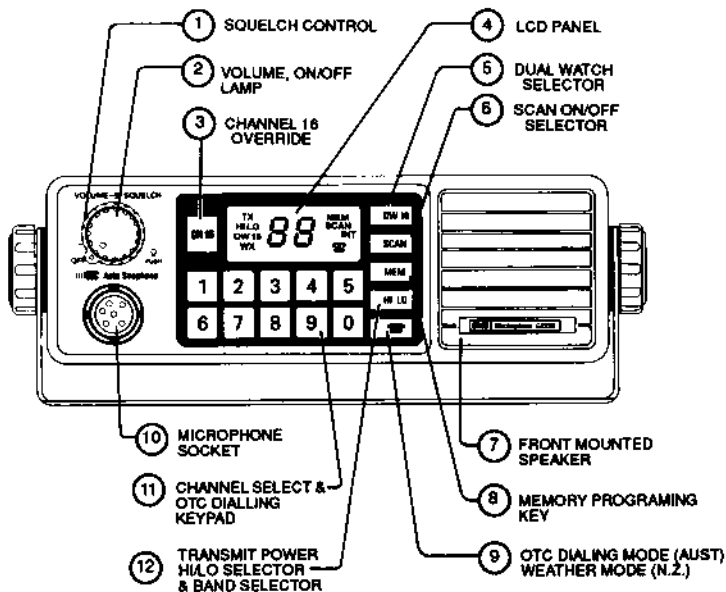

1. SQUELCH CONTROL.

Turning the squelch control clockwise quiets the receiver when there are no signals present and allows a quiet standby operation. It functions only in the receive mode and does not affect the receiver volume or the transmitted signal.

2. VOLUME ON/OFF LAMP CONTROL.

Volume ON/OFF - Rotate clockwise past the "click" to turn the transceiver on. Continue to rotate clockwise to increase the volume level from the speaker.
DIM CONTROL - Press the volume control inwards to control the panel lighting for night use. The lights operate in a cycle - OFF - DIM - FULL - OFF.

3. CHANNEL 16 OVERRIDE.

Pressing **CH 16** at any time causes the transceiver to go immediately to Channel 16.

(Channel 16 is the emergency safety and calling channel). Selecting Channel 16 cancels all other modes including SCAN and OTC DIALING modes. Transmitter output power is automatically set to maximum.

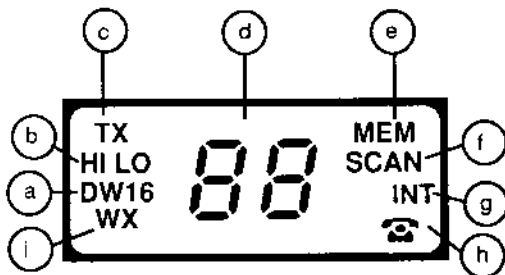

- | | |
|------------------------------------|---------------------------------------|
| (a). DUAL WATCH MODE INDICATOR | (f). SCAN MODE INDICATOR |
| (b). HI/LO POWER INDICATOR | (g). INTERNATIONAL BAND INDICATOR |
| (c). TRANSMIT MODE INDICATOR | (h). OTC AUTO DIALLING MODE INDICATOR |
| (d). 2 DIGIT CHANNEL DISPLAY | (i). WEATHER MODE INDICATOR |
| (e). "CHANNEL IN MEMORY" INDICATOR | |

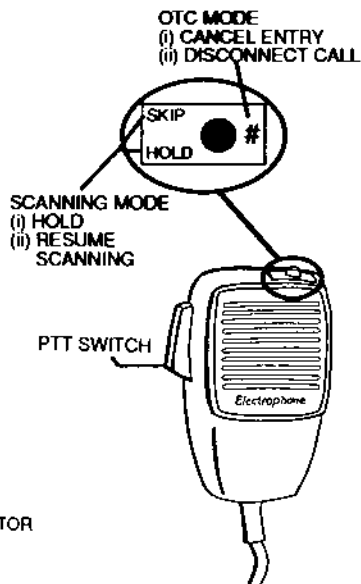

4. LCD PANEL.

The Liquid Crystal Display (LCD) panel displays the selected channel number and indicates which function or mode has been selected. This type of display can be easily read, even in direct sunlight. For low light or night viewing, panel lights are provided which light the display internally.

5. DUAL WATCH SELECTOR.

Pressing allows you to monitor both Channel 16 and a channel selected by the numeric keypad. "DW16" is displayed on the LCD panel. Signals appearing on Channel 16 will take priority over those on the selected channel.

6. SCAN ON/OFF SELECTOR.

Press to activate the scanning mode. This causes the GX558 to scan any channels which are programmed into the memory. Scan will pause when a signal appears on one of the channels and will not continue until the channel is clear. During this time the signal can be heard.

7. FRONT MOUNTED SPEAKER.

The powerful front mounted speaker projects the sound forward for maximum volume and clarity. The front mounted speaker allows the GX558 to be flush mounted in a bulkhead or dashboard using the flush mounting kit supplied.

8. **MEMORY PROGRAMMING KEY.**

The  Key is used to store channels in the memory. It can also be used to remove channels which have previously been stored.

When scanning, the  key can also be used to skip over a busy channel.

9. **WEATHER CHANNEL SELECTOR. (NEW ZEALAND VERSIONS ONLY)**

Press  and a channel number between 0 and 9 to select one of ten weather channels.

Press and Hold  to scan any weather channels stored in the memory.

OTC AUTO DIALLING MODE SELECTOR. (AUSTRALIAN VERSIONS ONLY)

Pressing the  Key activates the OTC AUTOMATIC DIALLING mode. In the OTC dialling mode you can make telephone calls anywhere in the world by directly dialling the required number on your GX558.

The  Key will not activate on channels which are unsuitable for OTC dialling, to prevent accidental dialling over other services.

10. **MICROPHONE SOCKET.**

The microphone plug should be inserted into this socket and the outer sleeve tightened. The microphone must be inserted to activate the speaker. Alternatively a telephone style handset can be plugged into the socket. The receiver audio will be transferred to the handset's earpiece.

11. **CHANNEL SELECTOR AND OTC DIALLING KEYPAD.**

During normal operation, the numeric keypad is used to enter the channel number. Any legal channel can be entered by pressing the channel number digits in sequence. Channels 1 to 9 should be prefixed with a zero.

During OTC dialling mode, the numeric keypad is used to enter the telephone number of the person you wish to call. When the PTT button is pressed, the number is sent automatically and the call is connected.

12. HI LO KEY.

The **HI LO** key has two functions -

* **POWER OUTPUT** - A momentary press of the **HI LO** key causes the transmitter power output to be set to either HIGH power (25 Watts) or LOW power (1 Watt). The power output will toggle between HIGH (Hi) and LOW (Lo) power with alternate presses of the key.

* **BAND SELECTOR** - Pressing and holding the **HI LO** key for about 1.5 seconds will cause the GX558 to change from the AUSTRALIAN VHF marine channel allocation, to the INTERNATIONAL VHF marine channels. "INT" is displayed in the LCD panel when the INTERNATIONAL band is selected. Press and hold again to return to the AUSTRALIAN channels.

Power is automatically reset to **HIGH** after a channel change or a mode change.

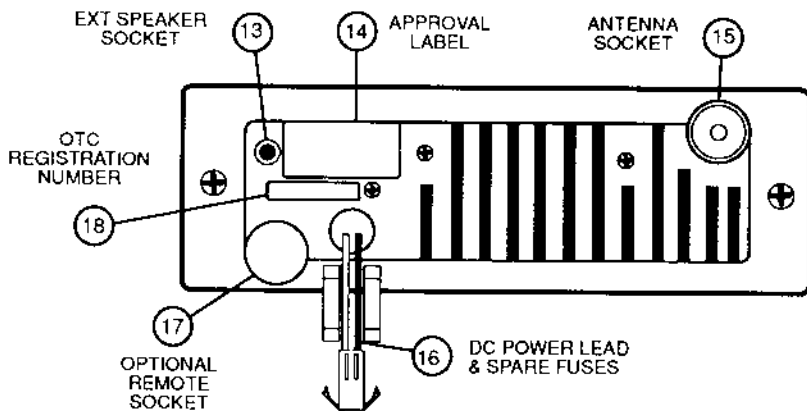

13. EXTENSION SPEAKER SOCKET.

This socket allows the use of an extension speaker. The internal speaker continues to operate when the extension speaker is plugged in to allow you to monitor the channel both at the radio and at a remote location (e.g. flybridge or cockpit). It is recommended to use an extension speaker when operating in noisy situations.

The impedance of the earphones or speaker connected to this socket must be in the range of 8 to 16 ohms.

14. **APPROVAL LABEL.**

The Approval Label contains the serial number of your GX558. It is recommended that you copy the serial number into the space provided at the front of this manual and keep it safe to enable identification should your radio be lost or stolen.

15. **ANTENNA SOCKET.**

For connecting to a 50 ohm antenna via a PL259 type coaxial plug. A correctly tuned 50 ohm antenna must be connected before attempting to transmit. Transmitting without an antenna or with an incorrectly tuned antenna may result in eventual damage to the transceiver.

16. **DC POWER CONNECTOR.**

Used to connect a 13.8 Volt DC power supply via the fused DC lead supplied. If the fuse blows, always replace it with the correct fuse rating. Damage caused by operating with a fuse of higher rating than that recommended is not covered under the warranty.

Two spare 10 Amp. fuses are supplied.

17. **REMOTE UNIT SOCKET OPTION.**

When fitted allows the connection of the optional remote control unit. The remote control unit looks exactly like your GX558 and allows all front panel functions to be duplicated at a remote station. In addition, an intercom feature is included so that the main unit and the remote station can communicate together.

The remote unit concept is especially designed for Flybridge applications.

The Socket, along with an interface board, must be fitted by a technician. If you require this option, you should return your GX558 to your dealer to arrange for the interface board and socket to be installed.

18. **OTC REGISTRATION NUMBER. (Australian Versions)**

This number is also on the back of the microphone. To operate the OTC AUTOMATIC DIALLING feature, you must register this number with OTC MARITIME. A registration form is supplied with your GX558. If you do not register this number, you will still be able to make SEAPHONE calls through the OPERATOR, but you will not be able to dial directly using the  feature.

An additional label has been supplied for fixing in a convenient location.

INSTALLATION

It is advisable to spend a little time selecting the best location for your GX558. The transceiver should normally be mounted horizontally. The universal bracket supplied can be fitted either above or below the case, enabling the transceiver to be cradled by the bracket, or suspended from it. Keep the following requirements in mind when choosing a suitable location.

1. Avoid positions where the unit might get wet. The design of the GX558 gives protection against accidental splashes and drips, but the equipment is not completely waterproof. Exposure to heavy rain, continuous spray, or immersion will result in damage to the transceiver.
2. Avoid exposure to direct sunlight for prolonged periods. This could cause overheating of the equipment and may eventually damage the plastic case and keypad.
3. Choose a spot where the microphone and all controls are easily accessible, and the loudspeaker can be heard from the normal steering position. An extension speaker may be installed if required. If your vessel has a Flybridge, you may consider installing the optional remote control unit in the Flybridge, allowing all front panel controls to be duplicated.
4. The GX558 depends on air circulation for cooling, so ensure that there is a clear space around the case and especially adjacent to the rear panel. A gap of at least 50mm (2 inches) behind the rear panel will also make it easier to install the antenna plug and power connector.
5. Components, and currents flowing in the transceiver create magnetic fields. To avoid interference to steering compasses or auto pilot sensors, the GX558 should be positioned at least 150cm (60 inches) from such equipment.

MOUNTING.

Your GX558 can be either bracket mounted, or "flush" mounted into a bulkhead or panel. To flush mount the GX558, you will need to use the "**flush mounting kit**".

Bracket Mounting.

Having selected a suitable location, hold the transceiver with the mounting bracket in the desired position and roughly mark the location using a pencil. Remove the mounting bracket from the radio and use the bracket as a template to mark and drill the mounting holes. Use a minimum of four self tapping screws (supplied). Remember that the fixings for overhead mounted units may have to withstand heavy pounding when the vessel is in rough water, or

being towed on a trailer.

When the bracket is installed, fit the GX558 using the rubber washers and the two large thumb screws. Tilt the radio up or down as necessary and tighten the screws.

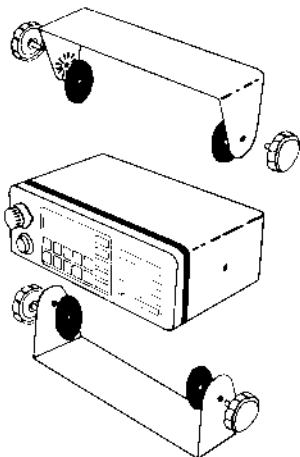

FIG. 1.

Flush Mounting.

1. Place the template (supplied in the kit) against the bulkhead or dashboard in the desired position and use a pencil to mark the slot for the radio.

When cutting the slot, make sure you don't inadvertently increase its width, as this would decrease the clamping area and reduce the mounting strength.

2. Slide the radio, front panel first, into the flush mounting escutcheon supplied from behind, and line up the mounting holes in the side plates. Remove the two screws from the rear of the GX558. (Fig. 2)

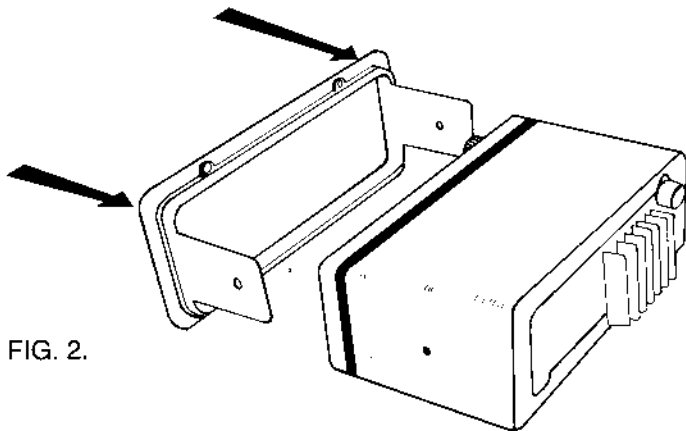

FIG. 2.

3. Insert the two brass flat head screws into the mounting holes in the side plates and tighten firmly. DO NOT OVERTIGHTEN. (Fig. 3)

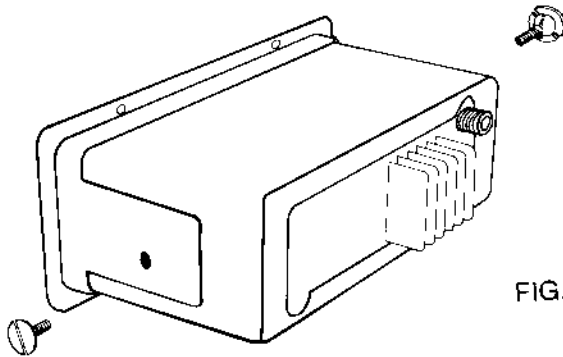

FIG. 3.

4. Slide the entire assembly, rear panel first, into the slot in the bulkhead, manoeuvring the assembly past the heads of the brass mounting screws in the sides, and push up firmly against the bulkhead. (Fig. 4)

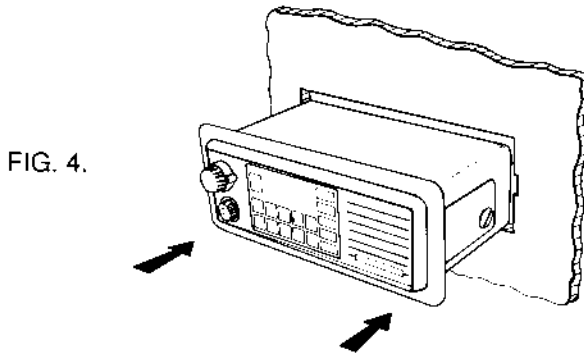

FIG. 4.

5. Working from behind the bulkhead, slide the two metal brackets over the heads of the brass screws and slide them all the way up to the inside of the bulkhead. (Fig. 5).

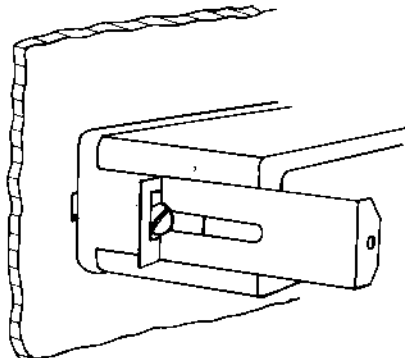

FIG. 5.

6. Install the two screws, which were removed earlier, into the holes in the metal brackets and tighten firmly against the rear of the GX558. Again, DO NOT OVERTIGHTEN. These screws will clamp the radio against the bulkhead and provide a firm mounting. (Fig. 6)

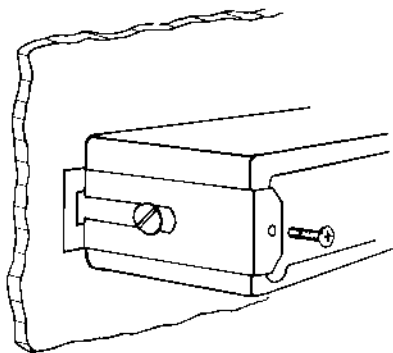
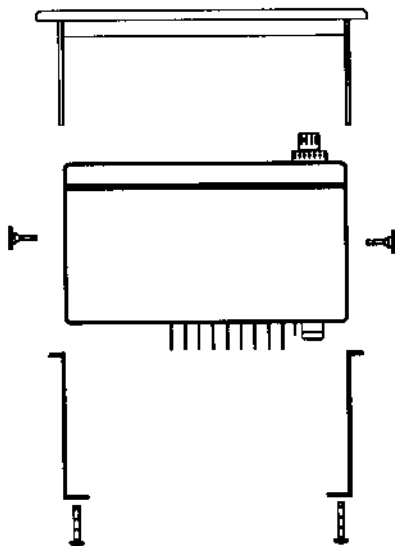
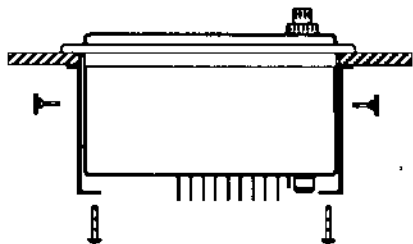
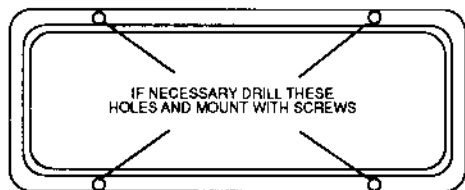

FIG. 6.

7. If required, extra strength may be obtained by drilling out the mounting studs inside the escutcheon and screwing the frame directly to the bulkhead. (Fig. 7). However, it is unlikely that this will be necessary. (Only to be used in conjunction with the assembly in steps 1 to 6 above.)

FIG. 7.



Two spare fuses are attached to the radio's power lead with heat shrink plastic. When required they can be removed as follows:-

Refer Fig. 10.

1. Hold the fuse and wire between the thumb and forefinger of your left hand with your thumb on the wire.
2. Grasp the wire in your right hand and pull the wire downwards to tear the heat shrink plastic.
3. Remove the fuse from the plastic and insert into the fuse holder.
4. To open the fuse holder, press the ends towards each other and rotate them counterclockwise. Release the pressure and the fuse holder will separate.

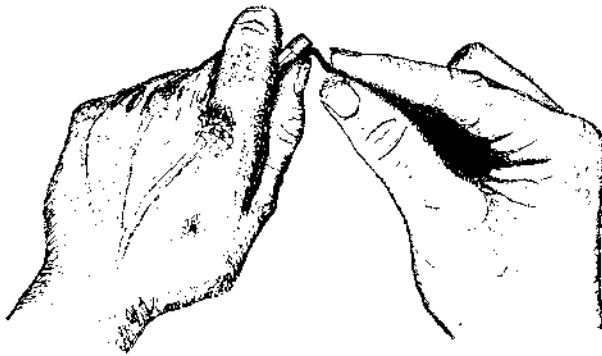

ANTENNA INSTALLATION.

NEVER TRANSMIT WITHOUT AN ANTENNA CONNECTED, OTHERWISE DAMAGE MAY RESULT TO THE TRANSCEIVER.

The communication range of your GX558 will increase in direct proportion to the height of the antenna used. For a yacht, the optimum position for a VHF antenna is at the masthead. For a cruiser, a location on or above the Flybridge will give best results. A VHF antenna should also be mounted well clear of other antennas or metal objects, such as awning supports, wire rigging, rail stanchions, etc.

Good quality 50 ohm co-axial cable must be used to connect the antenna to the transceiver. For short runs type RG58CU is suitable, but for longer runs such as to the masthead of a yacht, low loss RG213U will give better results.

GME ELECTROPHONE manufacture a range of approved pre-tuned marine VHF antennas, which are ideal for use with the GX558 and suitable for all types of vessels: Make your selection after studying the details given below.

AE30 VHF DECK MOUNT PRE-TUNED ANTENNA.

Length: 82cm

Ideal for aluminium or fibreglass runabouts. Whip section is removable or folds down to avoid damage.

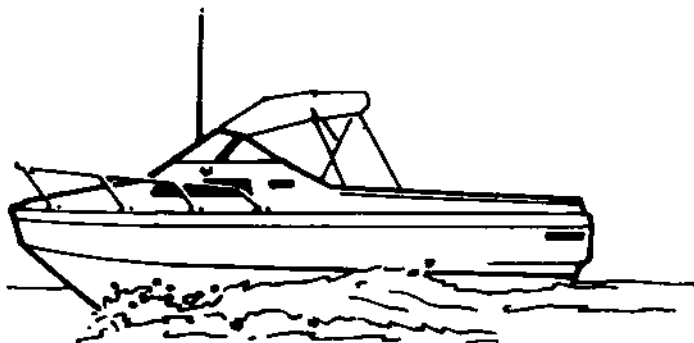
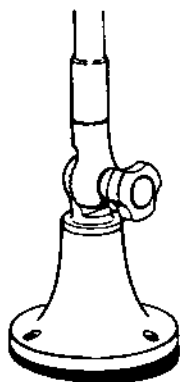

AE31 VHF MAST MOUNT PRE-TUNED ANTENNA.

Length: 85cm

Intended for mounting at the top of yacht masts or on special short masts to give increased range over deck mounted antennas. Comes complete with mounting bracket.

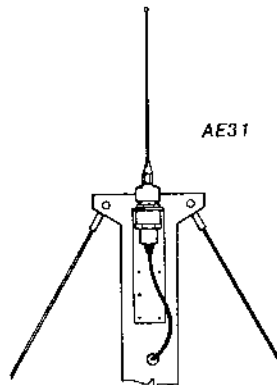
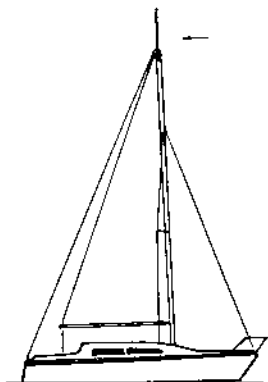

**AE87 VHF FLYBRIDGE MOUNT PRE-TUNED ANTENNA
WITH TWO WAY SWIVEL BASE.**

Length: 2.7m

Intended for larger runabouts or cruisers. Can be mounted on a vertical, horizontal or sloping surface and easily lowered for bridges, storage racks or towing.

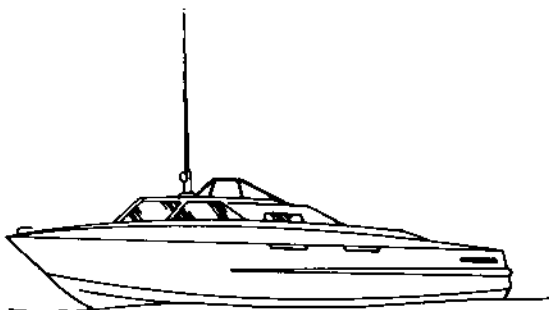
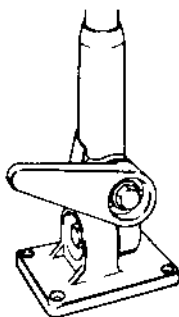

OPERATION

**DO NOT ATTEMPT TO TRANSMIT WITHOUT AN AERIAL CONNECTED OTHERWISE
DAMAGE MAY RESULT TO THE TRANSCEIVER'S OUTPUT CIRCUIT.**

RECEIVE OPERATING PROCEDURE

1. Ensure the 13.8 Volt power source, 50 Ohm antenna and microphone are correctly connected.
2. Adjust the squelch control fully counterclockwise.
3. Rotate the volume control clockwise past the "click" and advance it to a comfortable listening level.

SQUELCH

The squelch control is used to eliminate any annoying background noise when there are no signals present.

To adjust the squelch, turn the squelch control clockwise until the background hiss just disappears. At this point the receiver will remain quiet when there are no signals being received, but an incoming signal will overcome the squelch action and be heard from the speaker. As the control is advanced (in a clockwise direction) the squelch action is progressively increased and stronger incoming signals are needed to overcome it. To receive extremely weak signals or to disable the squelch circuit, simply turn the squelch control fully counterclockwise.

SELECTING CHANNELS.

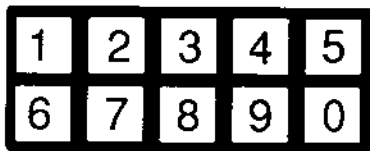

Channels are selected using the numeric keypad on the front panel

Press any two keys to enter a valid two digit channel number. A high beep will be heard at each keypress. Single digit channel numbers should be prefixed with a Zero (0).

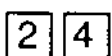
e.g. To select Channel 24,   . **24** is displayed.

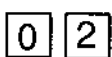
To select Channel 2,   . **2** is displayed.

The first digit entered will flash on the display. At this point, the second digit must be entered within three (3) seconds. If entered correctly, the channel number selected will be displayed and the GX558 will operate on that channel.

If the second digit is **NOT** entered within the correct time, the radio will assume a single digit channel number was required and will select that channel (on the condition that it is a valid channel number.)

e.g. Entering will, after three seconds assume was required, and

Channel 2 will be selected.

If the channel number selected is **NOT** a valid channel, a low beep will be heard (indicating an incorrect entry), and the radio will return to the last selected channel.

NOTE: When the channel is selected, HIGH transmit power will automatically be selected unless **LOW power is mandatory on the selected channel.**

CHANNEL 16 OVERRIDE.

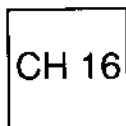

to immediately select the Distress, Safety and calling Channel 16

Pressing will cancel all other modes and functions, including OTC DIALLING and



scanning, and the GX558 will go straight to Channel 16. High transmit output power is selected automatically.

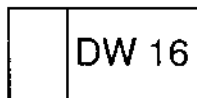

DUAL WATCH FUNCTION.



The Dual Watch Function will allow the GX558 to monitor Channel 16 **AND** any other selected channel. Any signals received on Channel 16 will take priority over signals on the selected channel.

1. Enter the channel number you wish to use.

e.g. To select Channel 26   . **26** will be displayed in the LCD Panel.

2.  , "DW16" will also be displayed in the LCD Panel.

3. Your GX558 will now operate on Channel 26, but will continue to monitor Channel 16 every 2 seconds

If there are no signals present on either channel, the selected channel number will be displayed along with "DW16".

If a signal appears on the selected channel, the signal will be heard, but the display will flash **16** every 2 seconds indicating that it is still monitoring Channel 16, and a brief interruption to the signal will be noticed at each time. This will continue for as long as the signal is present and for a further 5 seconds after the signal has gone (this allows the radio to hold the channel during short breaks in the conversation). The display will then return to the selected channel.

If at any time a signal appears on Channel 16, the receiver will immediately "lock" onto Channel 16 and **16** will be displayed. The receiver will remain on Channel 16 for as long as a signal is present, and for a further 5 seconds after the signal has gone. The display will then return to the selected channel and Dual Watching will resume.

Note:

When Dual Watching, any transmission you make will be on the selected channel. If you

need to reply to a call on Channel 16,   to exit the Dual Watch mode and go immediately to Channel 16.

SELECTING THE DISPLAY BRIGHTNESS.

The LCD Panel and Keypad can be lit to enable them to be easily read at night. The light is controlled by pressing the VOLUME knob inwards. Each press will change the light from OFF, to DIM, to BRIGHT, and back to OFF again.

When the radio is first turned on, the light is OFF.

1. Press the VOLUME knob ONCE. The display and keypad will be lit at half brightness.
2. Press the VOLUME knob again. The display and keypad will be lit at full brightness.
3. Press the VOLUME knob again. The light will be extinguished.

TRANSMITTING.

To TRANSMIT, press the PTT Button on the microphone. Hold the microphone 2-6cm from your mouth and slightly to one side, so that your voice does not project directly into the microphone. Speak at a normal level. Avoid raising your voice or shouting into the microphone.

Whenever the PTT button is pressed, the "TX" indicator in the LCD panel will appear.

CHANNEL 16.

Channel 16 is used for calling purposes or emergency use only. When contact has been established on Channel 16, you must switch to a working channel to continue your conversation. You should always monitor the channel before initiating a call.

When calling, identify your vessel name and your callsign.

POWER OUTPUT.



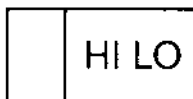

It is good practice to use low power output wherever possible. Using High power unnecessarily may cause interference to other people's communication.

SETTING THE TRANSMITTER OUTPUT POWER.



Alternate presses will select HIGH or LOW transmitter output power

When your GX558 is first turned on, or when a channel is selected, HIGH power is automatically selected.

1. To select LOW power   momentarily. A high beep will be heard and "LO" will appear in the LCD display.
2. To reselect HIGH power   again. A high beep will be heard and "HI" will appear in the LCD display.



When HIGH power is selected the transmitter output power is 25 Watts, reducing to 1 Watt on LOW power.

IMPORTANT NOTE: Some channels may be designated LOW power only. Your GX558 will automatically select LOW power on these channels and will not accept any attempt to select HIGH power. For details on these channels and their use, refer to the frequency chart on page 38.

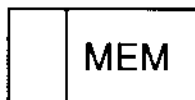
PROGRAMMING THE MEMORY





Use  to store selected channels in the memory or remove unwanted channels from the memory

Those channels stored in the memory can be "scanned" for signals when required, using the  function. The memory is large enough to store **ALL AVAILABLE CHANNELS** if you so require. Channels programmed into the memory will remain indefinitely until removed using the .



STORING CHANNELS.

- (i) Select the required channel using the numeric keypad.
- (ii) Check that "MEM" is **NOT** displayed in the LCD panel. This confirms that the channel is not in the memory.

NOTE: If there are no channels programmed in the memory, a two-tone beep will be heard and the  command will be ignored. In this case refer to the section on PROGRAMMING the memory.



3. To skip over a busy channel  
The receiver will move off that channel and resume scanning.

4. To HOLD on a channel either (i)   on the microphone.

or (ii)   

"MEM" will be displayed and the receiver will stay on the channel until commanded otherwise.

5. To Resume scanning when the channel has been held:



either (i)   on the microphone.

or (ii)  

The receiver will resume scanning.

6. To Exit the SCAN MODE:

either (i)   to return to the last selected channel.



or (ii)   to go to Channel 16.

or (iii)   to manually select a channel.



CHECKING WHICH CHANNELS ARE IN MEMORY.

The following method can be used to identify which channels are stored in the memory.



(i) Rotate the squelch control fully counterclockwise. The receiver hiss will be heard in the speaker.

(ii)  . If there are no channels stored in the memory a two tone beep will sound, and the scan command will be ignored.

If there are channels stored in the memory a high beep will sound, "SCAN" will be displayed along with a channel number. The displayed channel number will be one of those stored in memory.

(iii)   to reveal any other channels in the memory.



Each press of  will reveal the next channel. Continue until all memorised channels have been revealed.

(iv) When you have finished,   again to exit the SCAN mode, and readjust the Squelch Control.



SELECTING AUSTRALIAN OR INTERNATIONAL BANDS.

When operating within and around Australian waters, specific channels or frequencies have been allocated for specific uses. However, when operating outside this area, an International frequency allocation has been accepted.

Your GX558 has both allocations installed as standard, but will automatically select the Australian mode when turned on.

1. To select the International Band  and hold  for about 1.5 seconds.

Initially, the radio will beep and the transmitter power will change - continue holding the  key down until a second beep is heard. "INT" will be displayed indicating the radio is in INTERNATIONAL mode. You should now reselect the required transmitter power if necessary.

2. To return to the AUSTRALIAN channels  and hold  again. "INT" will disappear after the second beep.

CHANNEL 87A.

Channel 87A, as used by the Australian Yachting Federation, is installed in your GX558 as Channel 87 in the Australian band.

If normal Channel 87 is required, select the **International** Band and enter Channel 87 in the usual way.

WEATHER CHANNELS (NEW ZEALAND VERSIONS ONLY)



- With the  function, you can either select individually, or scan, up to 10 preset weather channels

Selecting Individual Channels.



and within 3 seconds any one of

1	2	3	4	5
6	7	8	9	0

e.g.

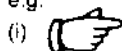

"WX" will be displayed, along with a flashing —



within 3 seconds.



—3 will be displayed, indicating that Weather Channel 3 has been selected.

NOTE: If you do not press one of

1	2	3	4	5
6	7	8	9	0

within 3 seconds, a beep will be

heard and the radio will return to the last selected channel.

Weather Channels in Memory.

Your GX558 is supplied with all ten weather channels installed in the memory. This means all ten channels can be scanned if required

If there are any channels you do not wish to scan, these can be removed using the following method.

1. Select the required weather channel



for Weather Channel 5. —5 will be displayed.

2. Check to see that "MEM" is displayed. This confirms that the channel is currently in the memory.

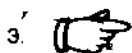

and hold MEM for about 1.5 seconds. A low beep will be heard and "MEM" will disappear from the display. The channel has now been removed from the memory.



4. Repeat the procedure above to remove any other weather channels not required.

The channels you have removed from the memory can be re-installed at any time by again selecting the required weather channel and holding until a high beep is heard. "MEM" will be displayed confirming that the channel is back in the memory.

Note: Removing weather channels from the memory prevents the GX558 from scanning these channels.



The channels you have removed can still be selected individually when required.



Scanning the Weather Channels.

To scan the weather channels,  and hold  for about 2 seconds.

Initially "WX" will be displayed and  will flash. Then, after two seconds, a high beep will be heard, "SCAN" will appear and the weather channels will be displayed as they are scanned.

If a signal is found on one of the channels, scanning will pause on that channel for as long as the signal remains, and for 5 seconds after the signal has gone. Scanning will then resume.

To manually force scanning to resume,  

To hold scanning indefinitely on a channel   # on the microphone. Press again to resume.

OTC SEAPHONE DIRECT DIALING. (AUSTRALIAN VERSIONS ONLY.)



The OTC AUTO SEAPHONE function enables you to direct dial any telephone number in Australia or overseas.

To operate the OTC AUTO SEAPHONE feature, you must first register the OTC Registration number, affixed to the rear panel of your GX558, with OTC MARITIME. A registration form has been supplied with your radio. If you do not register this number, you will still be able to make Seaphone calls through the operator, but you will not be able to dial directly using the  function.

The following buttons are used to control the AUTO SEAPHONE functions.

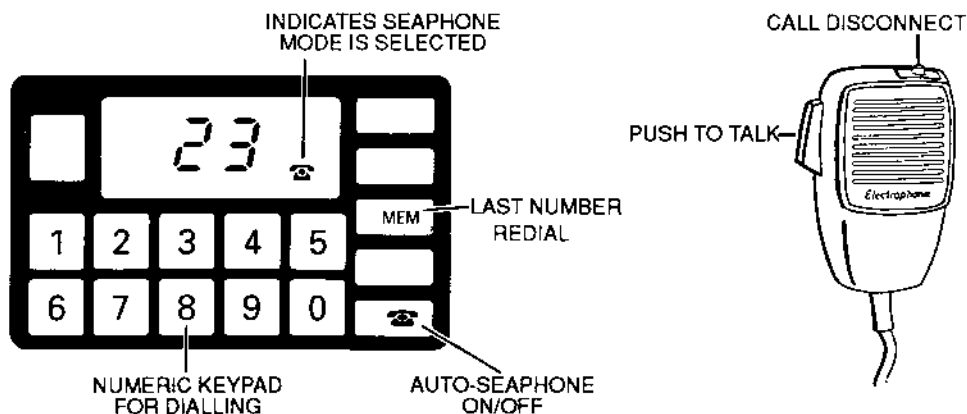





Notes:

- (i) All automatic calls will be guided by recorded voice announcements from the AUTO SEAPHONE system.
- (ii) The first press of the PTT will automatically send your Seaphone ID along with any telephone number entered. Subsequent presses of the PTT will operate the transmitter in the usual way.
- (iii) In Auto Seaphone mode, releasing the PTT button after each over causes a short beep to be transmitted as an indication to the other party that it is their turn to speak.

Ship to Shore Automatic Dialling.

1. Select a free Seaphone channel in your area and listen for several seconds to ensure the channel is not being used.

2.   to select the Direct Dialling mode. A high beep will be heard and  will be displayed. If the channel you are on is **not** for Seaphone use, a low beep will be heard. Reselect your Seaphone channel.

3. 

1	2	3	4	5
6	7	8	9	0

 to enter the telephone number, including the area code (even for local calls) or ISD code if necessary.

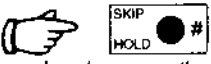

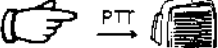
* If you make an error, simply  on the microphone to cancel the number. A high beep will be heard and you can then re-enter the number from the beginning.



4. Check the channel is still free, then  momentarily, within 15 seconds of entering the last digit. The GX558 will automatically transmit the telephone number and your built in Auto-Seaphone I.D.

* If you don't transmit the number within 15 seconds, it will be cleared and you will have to enter it again.

5. Within a few seconds your call will be validated, and a brief voice announcement will follow indicating "YOUR SEAPHONE CALL IS BEING CONNECTED". A normal ring tone will be heard, followed by the called party answering.



6. Operate the push to talk switch on the microphone and talk in the usual manner. Each time you release the PTT switch, a beep will be transmitted to let the other party know it is their turn to speak.



7. To terminate your call   on the microphone. This also resets the Auto Seaphone system ready for another call.

8. To exit the Auto Seaphone function and return to normal radio operation  . A beep will be heard and  will disappear.

LAST NUMBER REDIAL.

If the number you have dialled is busy, or you do not appear to have got through -

1. Wait a few minutes if necessary, then   to **REDIAL** the last number.
2. Proceed with your conversation in the normal way.

NOTE: Pressing  or  will remove the last number from the redial memory.

Shore to Ship Semi Automatic Calls.

All shore to ship calls are booked through the OTC operator by dialling **0108** (this is a free call).

1. The shore subscriber should ring the local OTC Maritime Communications Station on **0108** and provide details of:-

- (i) The Vessels Name.
- (ii) Auto Seaphone **Number**.
- (iii) Radio Call **Sign**.
- (iv) Probable Location.



2. The Seaphone operator will enter the information, including the shore party telephone number, into the Auto Seaphone system. The call is immediately registered as Seaphone traffic on hand for that particular vessel and when the connection is eventually made, the shore subscriber handles the call in the normal manner.



3. If the vessel cannot be immediately contacted, the data is held for 24 hours in the Auto Seaphone System and can be interrogated by the vessel during this time. Calls not connected within 24 hours must be rebooked.

Auto Interrogation.

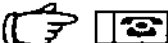
Skippers of Auto Seaphone equipped vessels can interrogate the OTC computer system at any time using the procedure below, to determine if there are any outstanding Seaphone calls on hand.

1. Select a Seaphone channel in your area and listen to ensure it is not in use.

2.  to select the direct dialling mode. A high beep will be heard and  will be displayed.

3.  $\xrightarrow{\text{PTT}}$  momentarily. Your Auto Seaphone I.D. will be transmitted.

Only the **FIRST** press of the PTT switch will transmit your Auto Seaphone identification to enable you to interrogate the OTC system. All subsequent presses of the PTT will operate the transmitter in the **USUAL** way.

4. An automated voice announcement will respond, indicating whether or not there are any calls for you.

5. If **there is a call on hand**, the Auto Seaphone system will dial the shore subscriber's telephone number and connect you automatically.



6. The call will terminate when either
(i) The shore party hangs up

or (ii) You   on the microphone.

Charges in this case are met by the shore subscriber.

7. If **there where NO CALLS for you** when you interrogated the system but you wish to remain in OTC mode and re-interrogate the system again, you should first press the  button on the microphone to clear the redial memory.

The  key can now be pressed as often as required to re-interrogate the OTC system.

8. To exit the Auto Seaphone function and return to normal radio operation   A beep will be heard and  will disappear.

Ship to Shore Manual Procedures.

If you have not registered your OTC Registration number, you can still make Seaphone calls using the manual procedure.

1. Select a Seaphone channel in your area and listen to ensure that it is free.
2. Press the PTT button on the microphone and call the Seaphone operator.

e.g. If you are in Sydney.

Call "Sydneyradio, Sydneyradio, Sydneyradio, this is (ship's name and callsign) (repeat) on channel (state the channel number you are calling on)"

Your call should not exceed 20 seconds. If there is no reply, repeat your call.

When the operator answers, Say "I wish to make a Seaphone call to (name of person, telephone number, city)."

You should then follow the operator's instructions. At the end of your conversation, you should say -"This is (ship's name and callsign) signing off.....out."

Don't forget to return your radio to Channel 16.

Seaphone Channels. (Auto and Manual)

At the time of printing, the following channels were available for Seaphone use in Australia.

02, 05, 23, 24, 25, 26, 27, 28, 60, 62, 67, 84, 85, 87, 88.

Some channels, due to frequency allocation and/or usage category, are not suitable for Seaphone operation, now or in the future, e.g. Channel 16. Your GX558 has been programmed to prevent accidental selection and operation of Seaphone Auto Dialling on those channels which could disrupt emergency or safety working, or specific commercial or professional operations.

For an up to date list of allocated channels and services in your area, you should obtain a copy of the RADIO SERVICES GUIDE from:

OTC Maritime
PO Box 340, ST LEONARDS. N.S.W. 2065
Ph. (02) 287 3030.
Other Areas. Ph. (008) 26 9977

999 EMERGENCY SERVICE.

Emergency and distress communications normally make use of Channels 16 and 67 as necessary. However, the Auto Seaphone System will enhance this arrangement by providing an Auto Dial marine emergency option. This is especially useful in areas where channels 16 and 67 may not be available yet, such as the Hawkesbury in N.S.W.

By dialling "999" on any Seaphone channel within range of your vessel, an immediate high priority alarm will be activated, and the Auto Seaphone system will automatically display your vessel's name, call sign, owners name and address for the Seaphone operator's immediate attention.

The emergency "999" function will override any established Seaphone Call in progress on the selected channel and will be followed by a special automatic announcement saying "**EMERGENCY CALL RECEIVED. ALL VESSELS PLEASE STAND BY**".

IMPORTANT REMINDER.

If you have registered your OTC Registration number with OTC MARITIME, please advise them immediately in the event of any of the following circumstances:-

- (i) Change of your address.
- (ii) Sale of your vessel and/or your GX558.
- (iii) Loss or theft of your GX558.

Address your letter to -

Product Manager OTC Maritime,
PO Box 340,
ST LEONARDS. N.S.W. 2065

OPERATING ON THE VHF MARINE BAND IN AUSTRALIA

Qualifications.

Any person in Australia operating a VHF marine transceiver should possess a Restricted Radio Operators Certificate of Proficiency (ROCP). This certificate is issued by the Department of Transport and Communications (DOTC) to candidates who successfully pass a simple theory and practical examination. Persons wishing to obtain a ROCP should first purchase a copy of HANDBOOK FOR RADIOTELEPHONE SHIP STATION OPERATORS available from the DOTC or most marine booksellers. This contains full information on all aspects of marine radio operation and the ROCP examination.

Normal Operation.

Channel 16 is the international VHF Calling and Distress Channel. It is monitored 24 hours a day by OTC Coast Stations and during daylight hours by Coastguard organisations, etc.

All vessels, ranging from pleasure craft to supertankers, generally monitor Channel 16 when not using other channels for communications.

Channel 16 is normally used to make initial contact with the ship or shore station being called. Both stations then change to a working channel to pass their messages, leaving Channel 16 clear for other initial calls or distress. Channel 67 is designated as a supplementary safety channel, and is used by coast stations for broadcasting weather forecasts, etc.

The following points will help to make operating easier.

1. Whenever your GX558 is turned on, but not in actual use, keep the receiver tuned to Channel 16.

Either (a) Select Channel 16 directly.

or (b) Dual Watch Channel 16 and another channel.

or (c) Ensure Channel 16 is included in the scan memory when scanning.

This will allow you to listen for other vessels in distress in case you are able to assist. It also allows you to hear any safety broadcasts for your area, including weather warnings. In addition, this is the channel where others will expect to be able to contact you.

2. Use your Callsign at the beginning and end of your transmission to allow others to identify you.

3. When you have made contact, move to an appropriate working channel immediately, so that Channel 16 is left clear.

4. Use low transmitter power as much as possible. Using high power unnecessarily, especially when you are close to the boat you are talking to, could increase the chance of interference to other vessels communications.

5. Never use obscene language on the air. Apart from being illegal, you never know who may be listening.

6. Never transmit or allow anyone on your vessel to transmit a false distress message.

7. Refer to the list of channel frequencies on page 38. You will find that many channels have been assigned a specific purpose. We recommend that you check with an experienced operator to identify any special uses for channels in your area.

Seaphone.

The OTC Seaphone Service provides a radio link between vessels off the Australian coast and telephone subscribers anywhere in the world. The channels used are shown in the frequency chart on page 38. Calls may be originated by vessel or a shore subscriber as required. See the section on OTC Seaphone Autodialling.

Range.

The range of VHF transmissions depends on antenna height, transmitter power and the terrain over which the signals pass. Ship to ship communications should be possible over a minimum

of at least 8 nautical miles and a maximum of about 27 nautical miles. Ship to shore ranges will often be greater due to the increased height of the shore antenna, and communications of 25 to 50 nautical miles are possible.

Emergencies.

If human life or your vessel is in imminent danger, make an initial call on Channel 16 as follows:-

1. The distress signal MAYDAY spoken three times, followed by the name of the vessel and call sign spoken three times.
2. Details of your position in latitude and longitude or in relation to a well known geographical feature.
3. The nature of distress and the kind of assistance required.
4. Any other information which may aid rescue, such as description of the vessel, number of people on board, etc.

Where life or the vessel is not in immediate danger, but an urgent message concerning safety is to be transmitted, use the urgency signal PAN PAN spoken three times in place of MAYDAY at the start of the message.

Emergency Antenna.

If your VHF antenna is damaged or falls in the water, a temporary antenna can be made as follows:

1. Cut the coax cable from the antenna so that as much cable as possible is retained. (Fig. 10)
2. Cut around the black outer case about 460mm (18 inches) from the end of the coax, and remove that section of casing. (Fig. 11)
3. Spread the braid where it protrudes from the casing and pull the centre wire through the gap. Pull the centre wire all the way through. (Fig. 12)
4. Fold the braid back against the coax and arrange the cable vertically using string or fishing line with the centre conductor as high as possible and away from any metal. (Fig 13.)

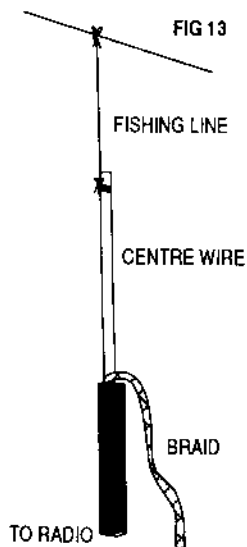
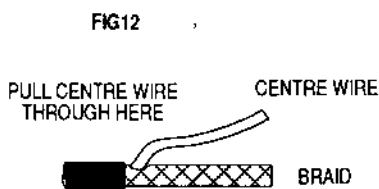
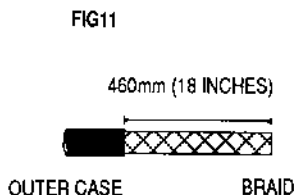
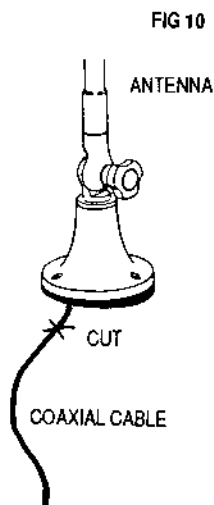

VHF MARINE CHANNEL ASSIGNMENTS.

INT. CHANNEL NUMBER	AUST. CHANNEL NUMBER	FREQUENCY (MHz)		USE
		TRANSMIT	RECEIVE	
1	1	156.05	160.65	Public Correspondence, Port Operation
2	2	* 156.10	160.70	Public Correspondence, Port Operation
3	3	156.15	160.75	Public Correspondence, Port Operation
4	4	156.20	160.80	Public Correspondence, Port Operation
5	5	* 156.25	160.85	Public Correspondence, Port Operation
6	6	156.30	156.30	Intership Safety
7	7	156.35	160.95	Public Correspondence, Port Operation
8	8	156.40	156.40	Commercial
9	9	156.45	156.45	Commercial, Non Commercial
10	10	156.50	156.50	Commercial
11	11	156.55	156.55	Commercial
12	12	156.60	156.60	Port Operation
13	13	156.65	156.65	Navigational
14	14	156.70	156.70	Port Operation
15	15	156.75	156.75	Environmental
16	16	156.80	156.80	Distress, Safety and Calling
17	17	156.85	156.85	
18	18	156.90	161.50	Commercial
19	19	156.95	161.55	Port Operation
20	20	157.00	161.60	Port Operation
21	21	157.05	161.65	Port Operation
22	22	157.10	161.70	Port Operation
23	23	* 157.15	161.75	Public Correspondence
24	24	* 157.20	161.80	Public Correspondence
25	25	* 157.25	161.85	Public Correspondence
26	26	* 157.30	161.90	Public Correspondence
27	27	* 157.35	161.95	Public Correspondence
28	28	* 157.40	162.00	Public Correspondence
60	60	* 156.025	160.625	Public Correspondence, Port Operation
61	61	156.075	160.675	Public Correspondence, Port Operation
62	62	* 156.125	160.725	Public Correspondence, Port Operation
63	63	156.175	160.775	Port Operation, Commercial.
64	64	156.225	160.825	Public Correspondence, Port Operation
65	65	156.275	160.875	Public Correspondence, Port Operation
66	66	156.325	160.925	Public Correspondence, Port Operation
67	67	* 156.375	156.375	Supplimentry distress and safety
68	68	156.425	156.425	Non Commercial
69	69	156.475	156.475	Non Commercial
70	70	# —	—	(Operation Prohibited)
71	71	156.575	156.575	Non Commercial
72	72	156.625	156.625	Non Commercial
73	73	156.675	156.675	Port Operation
74	74	156.725	156.725	Port Operation
75	75	# —	—	Guard Channel (Operation Prohibited)
76	76	# —	—	Guard Channel (Operation Prohibited)
77	77	156.875	156.875	Commercial
78	78	156.925	161.525	Non Commercial
79	79	156.975	161.575	Port Operation
80	80	157.025	161.625	Port Operation
81	81	157.075	161.675	Port Operation
82	82	157.125	161.725	Port Operation, Public Correspondence
83	83	157.175	161.775	Public Correspondence
84	84	* 157.225	161.825	Public Correspondence
85	85	* 157.275	161.875	Public Correspondence
86	86	157.325	161.925	Public Correspondence
87	—	* 157.375	161.975	Public Correspondence
—	87A	157.375	157.375	Non Commercial
88	88	*157.425	162.025	Public Correspondence

NOTES: *Allocated Seaphone Channels.

Operation is prohibited on Channels 70, 75 and 76.

VHF MARINE WEATHER CHANNELS (NEW ZEALAND VERSION ONLY)

CHANNEL	FREQUENCY (MHz)		USE
	RECEIVE	TRANSMIT	
WX0	163.275	---	WEATHER
WX1	162.550	---	WEATHER
WX2	162.400	---	WEATHER
WX3	162.475	---	WEATHER
WX4	162.425	---	WEATHER
WX5	162.450	---	WEATHER
WX6	162.500	---	WEATHER
WX7	162.525	---	WEATHER
WX8	161.650	---	WEATHER
WX9	161.775	---	WEATHER

THE FOLLOWING IS A LIST OF SPECIFIC CHANNEL ASSIGNMENTS IN NEW ZEALAND

CHANNEL	USE
16	Distress, Safety and Calling
6	Intership Working
7	Intership Working
8	Intership Working
9	Communications with NZ Coast Stations
12	Communications with NZ Coast Stations
13	Communications with NZ Coast Stations
14	Communications with NZ Coast Stations
67	Communications with NZ Coast Stations
69	Communications with NZ Coast Stations
73	Communications with NZ Coast Stations
21	Reception- Automatic Weather Information
24	RADPHONE Service
25	RADPHONE Service
26	RADPHONE Service
27	RADPHONE Service
28	Duplex- General Use
60	Duplex
61	Duplex
62	Duplex
63	Duplex
64	Duplex
68	Rescue Organisations Nationally
# 70	Digital Selective Calling Only
71	For communications with coastal stations after initial contact on channel 16
74	
73	Communications with coast stations in conjunction with marina's
77	Communications during aquatic events
88	Search and rescue through repeaters

Transmission on this frequency is prohibited unless equipment is fitted with digital selective calling

WARRANTY

GME ELECTROPHONE limit this Warranty to the original Purchaser of the equipment.

GME ELECTROPHONE warrant this product to be free from defects in material and workmanship for a period of twelve (12) months from the date of purchase from their authorised dealer.

Should the product require servicing during this period, all labour and parts used to effect repairs will be supplied free of charge. GME ELECTROPHONE reserve the right to determine whether damage has been occasioned by accident, misuse or improper installation whereby the Warranty would be void, including:

Transceivers which have been damaged due to:

(a) Incorrect reverse polarity connection to a battery or power supply;

(b) Connection to incorrect supply voltage.

(c) Operation without an antenna or by connection to an antenna which has been incorrectly installed, resulting in damage to the transceiver's output transistors.

(d) Effects of water or moisture penetration.

(e) Non-factory modifications.

(f) Use of incorrect replacement fuse.

Procedure to be followed by claimant: In the event of a defect occurring during the twelve (12) month Warranty period, the original purchaser may return the defective unit along with suitable proof of purchase date (i.e. receipt, docket, credit card slip etc) and a full description of the defect to the Dealer from whom the unit was purchased.

All freight charges incurred for transportation by the Dealer or GME ELECTROPHONE are the Purchaser's responsibility.

The Dealer will forward it to the closest authorised GME ELECTROPHONE Service Depot in your particular State.

GME ELECTROPHONE AFTER SALES SERVICE

Your ELECTROPHONE transceiver is especially designed for the environment encountered in marine installations. The use of all solid state circuitry, careful design and rigorous testing, result in high reliability. Should failure occur however, GME ELECTROPHONE maintain a fully equipped service facility and spare parts stock to meet the customer's requirements long after expiry of the warranty period.

Distributed via
National Dealer
Network by:

GME

Electrophone:::

A DIVISION OF **STANDARD COMMUNICATIONS** PTY. LTD.

SYDNEY

6 Frank Street,
GLADESVILLE 2111
(02) 816 4755
FAX: (02) 816 2198
Telex: AA26827 SCGME

MELBOURNE

96 Voltri Street,
MENTONE 3194
(03) 584 8099
FAX: (03) 584 8446

BRISBANE

Unit 1, 16 Dulacca Street
ACACIA RIDGE 4110
(07) 273 4355
FAX: (07) 273 5907

ADELAIDE

Unit 1, 22 Payneham Road,
STEPNEY 5069
(08) 363 1888
FAX: (08) 363 1471

PERTH

Unit 4, 43 Norma Road,
MYAREE 6154
(09) 330 5322
FAX: (09) 317 1787

AUCKLAND N.Z.

Unit F, 35 Neil Park Drive,
EAST TAMAKI
(09) 274 0955
FAX: (09) 274 0959