

Gloss white art stock – 130 gsm

Trimmed document size: 108 mm (w) x 198 mm (h) 44 pages

Book to be saddlestitched in 2 places

Printed in CMYK throughout with gloss Aq varnish



INSTRUCTION MANUAL

TX6500S

5 watt UHF CB handheld radio



ScanSuite™



IP67 Dust and Waterproof



Intelligent Battery Management



Pure Sound



Advanced Signal Management



Dynamic Volume Control



Voice Inversion Scrambler



ScanSuite™ 
faster, smarter scanning

CONTENTS

ACCESSORIES SUPPLIED.	3	Scan Groups	16
INTRODUCTION	3	Open Scan.	17
IMPORTANT ADVICE.	3	Group Scan	18
SAFETY INFORMATION.	3	Auto Skip	19
IMPORTANT INFORMATION - UHF CB RADIO	3	Additional Open/Group Scan Options.	19
FEATURES	4	Network Scan (Net-Scan).	20
LCD Icons.	6	Using the Priority Channel while Scanning	22
CONTROLS.	7	SelCall	22
GETTING STARTED	8	SelCall Identification Number (IDENT)	22
GENERAL OPERATION	10	The Quiet Mode (Q).	22
Power On/Off	10	SelCall Memories.	22
Adjusting the Volume	10	Ident or Alpha Name	23
Display Lighting.	10	Sending a SelCall.	23
Receiving Signals.	10	Adding Alpha names to SelCall Idents	24
Signal Strength Meter	11	Receiving SelCalls	25
Transmitting	11	Quiet Mode.	26
Squelch	12	Scanning in the Quiet Mode.	27
Selecting Channels	12	Group Calling	28
Priority Channel.	12	CTCSS & DCS.	29
Time-out Timer	13	CTCSS Tone Set Compatibility	29
Silent Squelch Tail	13	Monitor Function.	30
Key Beeps	13	Busy Lockout.	30
Voice Scrambler.	13	CTCSS TONE FREQUENCIES	31
Minimum Volume	14	DCS TONE CHART.	31
Display Contrast	14	RECEIVE (RX) ONLY CHANNELS	32
Dynamic Volume Control (DVC)	14	Channel Editor	33
Function Key	15	Signal Meter Display	36
Keypad Lock	15	MENU FUNCTIONS.	37
OS/GS Key.	15	CONSERVING YOUR BATTERY POWER	38
HI/LO Power	15	UHF CB OPERATING FREQUENCIES	39
Duplex	15	SPECIFICATIONS	40
SCANNING	16	STANDARD COMMUNICATIONS CONTRACT WARRANTY AGAINST DEFECTS	42
Overview.	16		

INTRODUCTION

Your TX6500S 80 channel radio is Australian designed and built and is the most advanced UHF Citizen Band radio available. Combining the very latest in electronic hardware with the most up-to-date computer aided design and manufacturing techniques has resulted in a mobile radio with outstanding specifications and performance.

SUPPLIED WITH

- TX6500S radio
- 2000 mAh Li-Ion battery pack
- PS001 power supply
- BCD013 rapid desktop charger
- Belt clip
- Instruction manual

IMPORTANT ADVICE

READ ALL INSTRUCTIONS carefully and completely before operating your radio and retain this manual for future reference.

- NEVER connect the radio to a power source other than the supplied battery. This may damage your radio.
- DO NOT place your radio in front of a vehicle airbag.
- DO NOT use your radio with a damaged antenna.
- DO NOT attempt to modify your radio in any way.
- ALWAYS charge your radio at normal room temperature.
- ALWAYS switch off your radio where notices restrict the use of two-way radio or mobile telephones.
- ONLY use GME approved rechargeable battery packs with the supplied charger.
- AVOID storing or charging your radio in direct sunlight.
- AVOID storing or using your radio where temperatures are below -20°C or above $+60^{\circ}\text{C}$.

SAFETY INFORMATION

The TX6500S is a radio transmitting device.

- When transmitting, keep the antenna more than 25 mm from any part of the head or body.
- People wearing pacemakers are recommended to maintain at least 15cm separation between any handheld radio and their pacemaker. If any type of interference is suspected, turn the radio off immediately.
- Do not transmit near electrical blasting equipment or in explosive atmospheres.
- Do not allow children to operate a radio transmitter unsupervised

IMPORTANT INFORMATION CONCERNING UHF CB RADIO

The use of the Citizen Band radio service is licensed in Australia by the ACMA Radiocommunications (Citizens Band radio Stations) Class Licence and in New Zealand by the Ministry of Economic Development New Zealand (MED). A General User Radio Licence for Citizens Band radio and operation is subject to conditions contained in those licences.

The class licence for users and equipment operating in the CB/PRS 477 MHz band has been amended. This radio meets the new 80 channel standard.

In simple terms the same amount of spectrum is available; however, radio transceivers can now operate in a narrower bandwidth and hence use less spectrum. These radios are generally referred to as narrowband or 12.5 kHz radios. By using 12.5 kHz channel spacing instead of 25 kHz, the 40 channels originally allocated can now be expanded to 80 channels thereby doubling the channel capacity and relieving congestion in the UHF CB/PRS band.

Original 40 channel wideband radios will continue to operate on the original 40 channels, however they will not be able to converse on the newer channels 41 – 80. The newer narrowband radios will be able to converse with all older 40 channel wideband radios on all channels 1 to 40 as well as the newer channels allocated from 41 to 80.

The mixing of narrowband and wideband radios in the same spectrum can cause some possible operating issues of interference and varying levels of received volume.

POSSIBLE ISSUES

When a new narrowband radio receives a transmission from an older wideband radio the speech may sound loud and distorted – simply adjust your radio volume for best performance.

When an older wideband radio receives a signal from a new narrowband radio, the speech may sound quiet – simply adjust your radio volume for best performance.

Depending on how close your receiving radio is to another transmitting radio, there can be interference from the transmitting radio if it is using a channel adjacent to the channel you are listening to. Simply try going up or down a few channels from the currently selected channel.

The above situations are not a fault of the radio but a symptom of operating wideband and narrowband radios in the same bandwidth. This possible interference will decrease over time as the population of wideband radios ages and decreases.

Further information and updates are available from the Australian Communications and Media Authority (ACMA) at www.acma.gov.au and the Ministry of Economic Development (MED), Radio Spectrum Management at: www.rsm.govt.nz

EMERGENCY CHANNELS

The ACMA has allocated channels 5/35 for emergency use only. Channel 5 is the primary Simplex Emergency Channel. Where a channel 5 repeater is available, you should select Duplex on CH 5.

NOTE: Channel 35 is the input channel for the channel 5 repeater therefore channel 35 should also not be used for anything other than emergency transmissions.

TELEMETRY CHANNELS

ACMA regulations have allocated channels 22 and 23 for telemetry-only applications and have prohibited the transmission of speech on these channels. Consequently the radio has a transmit-inhibit applied to channels 22 and 23.

In the event that additional telemetry/telecommand channels are approved by the ACMA, these channels shall be added to those currently listed where voice transmission is inhibited. Currently, transmissions on channels 61, 62 and 63 are also inhibited and these channels are reserved for future allocation.

FEATURES

TRANSMIT (TX)

Individually Programmable Duplex Function: User selectable only for those individual channels in your area that have repeaters, leaving the others free for use as extra simplex channels.

RECEIVE (RX)

Silent Squelch Tail: Eliminates the Squelch noise burst in a receiving radio.

User Programmable Receive Channels: 95

Signal Receive Indicator

SCANNING AND MEMORY FUNCTIONS

Microprocessor Controlled Frequency Synthesiser: Allows user programmable control of scanning, SelCall, CTCSS, channel memories, user selectable frequencies and selected feature options.

Programmable Scan Function: Scans the selected UHF channels with Group, Open and Network Scan functions available.

Priority Channel: A user programmable priority channel feature allows any channel of your choice to be instantly recalled at the press of a key.

Advanced Power Saving Feature: Allows the TX6500S to 'sleep' during periods of inactivity to conserve battery power.

PRIVACY FUNCTIONS

Voice Inversion Scrambler: When activated, scrambles your voice so that communications are only intelligible to others using the same scrambler technology.

In-Built CTCSS & DCS: User selectable Continuous Tone Coded Squelch System and Digital Coded Squelch system provides silent operation on individual channels.

In-Built SelCall with Quiet Mode: Provides selective calling of individuals or groups with fully user-adjustable 5-tone transmitted SelCall Ident. Also allows alphanumeric naming of up to 10 Idents for easier caller identification.

PHYSICAL PROPERTIES

Water & Dust Proof IP67: Provides protection against dust and temporary immersion in water

Rugged Construction: With Die-cast Chassis

Battery Pack: Heavy Duty 7.4v 2000 mAh Li-ion

USER CONTROLS AND INTERFACE

High Contrast Liquid Crystal Display: Fully detailed LCD provides a visual indication of the channel and all selected functions at a glance.

LED Backlight: For night viewing with automatic timeout

Keypad Lock: Prevents accidental key presses from disrupting the normal operation of your radio

Digital Signal Strength Meter: Provides a numeric signal strength indication in numbers from 0 to 9+.

SIGNAL PROCESSING

Digital Signal Processing (DSP): Measures, filters and compresses standard analogue audio signals and converts them into digital format. Allows advanced RF and audio processing techniques to be applied to maximise the radio's performance.

Advanced Signal Management (ASM): Identifies interference caused by strong local signals on adjacent channels and prevents it from opening your Squelch. ASM also minimises distortion on reception by fine tuning the receiver frequency to match that of the incoming signal. This prevents your Squelch from opening to unwanted interference and ensures that incoming signals remain clear and undistorted even when they are slightly off-frequency.

Dynamic Volume Control (DVC): Automatically compensates for variations in received audio level resulting in a constant audio output level to the speaker.

LCD ICONS

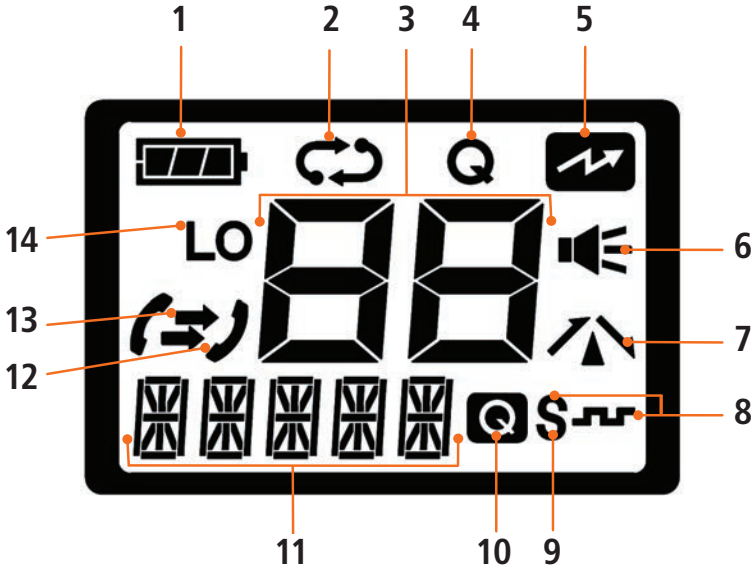

- | | |
|---------------------------|---------------------------|
| 1. Battery icon | 8. DCS icon |
| 2. Scan icon | 9. CTCSS icon |
| 3. Channel display | 10. Quiet icon |
| 4. Quiet-Tag icon | 11. Information display |
| 5. Transmit icon | 12. SelCall-Received icon |
| 6. Busy icon | 13. SelCall-Sent icon |
| 7. Duplex (repeater) icon | 14. Low transmit power |

CONTROLS

FRONT

REAR

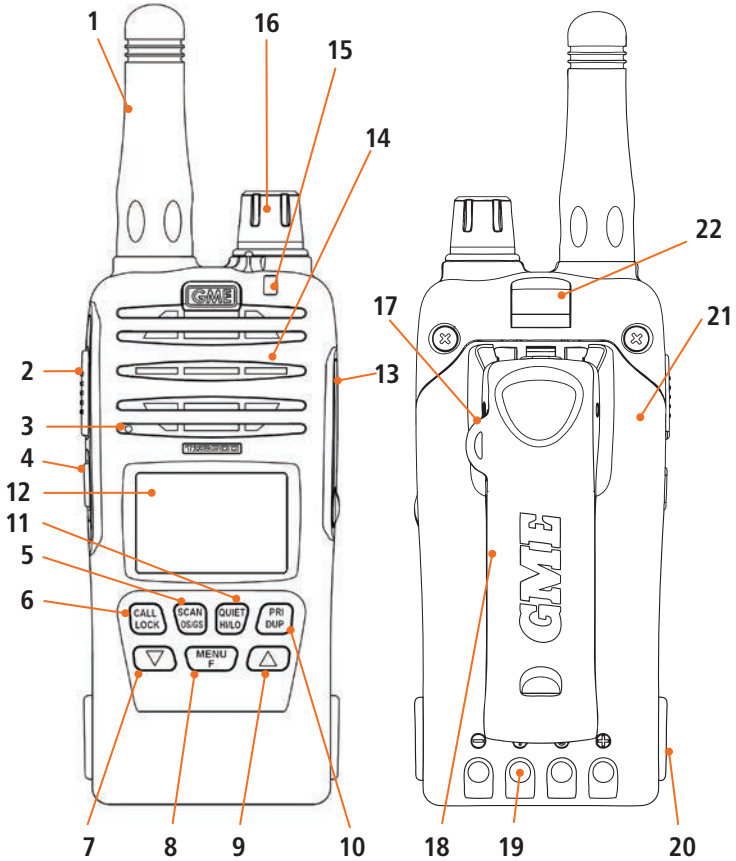

- 1. Antenna
- 2. PTT button
- 3. Microphone
- 4. Squelch/Monitor/
Silent Key
- 5. Scan/OS-GS key
- 6. Call/Key Lock Key
- 7. Down Key
- 8. Menu/Function Key

- 9. Up Key
- 10. Priority/Duplex Key
- 11. Quiet/Hi-Lo Key
- 12. LCD
- 13. Accessory Connector
- 14. Speaker
- 15. Indicator LED
- 16. Volume Control

- 17. Lanyard Point
- 18. Belt Clip
- 19. Charge Contacts
- 20. Battery Charger
Locating Tabs
- 21. Battery
- 22. Battery Release

GETTING STARTED

Your TX6500S is supplied with a 7.4 Volt 2000 mAh Li-ion rechargeable battery pack. When the battery is new, it must be fully charged before being used for the first time.

If left unused your TX6500S's battery pack will discharge itself within a few months. If you have not used your TX6500S for some time, you will need to recharge the battery pack before use.

The battery pack is a sealed unit. There are no user serviceable parts inside.

WARNING: Use only GME approved battery packs and chargers. Use of other types may be dangerous and will void the warranty.

To fit the battery pack

The base of the battery pack is retained in two slots at the base of the radio.

1. Carefully position the two tongues at the base of the battery pack into the slots in the base of the radio.
2. Swing the top half of the battery pack into place against the radio.
3. Press the top half of the battery firmly onto the radio until the locking tab clicks upwards locking the battery pack into place.

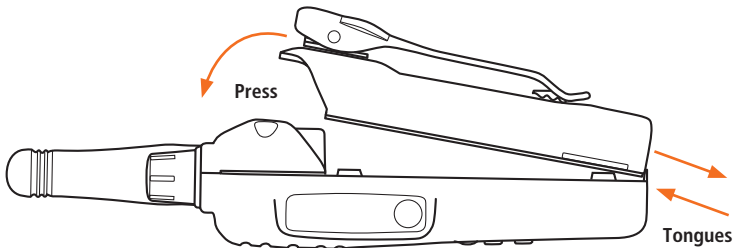

To remove the battery pack

1. Hold the radio face down in one hand.
2. With your thumb, push the locking tab downwards until it clicks.
3. The top of the battery will be released just below the locking tab.
4. Swing the top half of the battery pack away from the radio with the other hand.
5. Once clear of the locking tab, lift the battery upwards away from the radio.

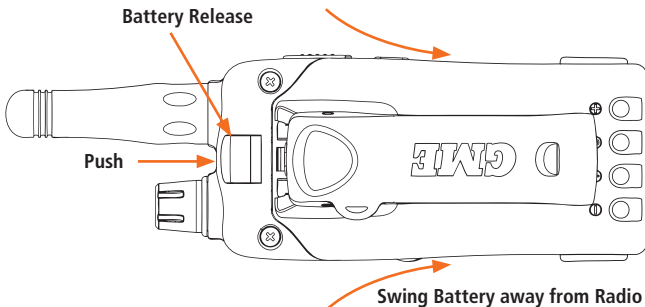

Charging the battery pack

Your TX6500S includes a BCD013 rapid desktop charger and a PS001 AC adaptor. The rapid charger will recharge the battery pack in around 3 hours.

To charge the battery:

1. Plug the PS001 AC adaptor into a standard 240 volt outlet.
2. Plug the lead from the PS001 into the charging socket on the rear of the BCD013 radio charger.
3. Place the TX6500S with battery attached into the charging slot. The Red charging LED will light up.
4. Once the battery is charged, the LED will change to Green.

NOTE: If the charger detects a fault condition and is unable to charge the battery, the Red charge LED will flash.

Battery life

The time taken to discharge the battery pack will depend on how you use your TX6500S. The 2000 mAh battery pack is powerful enough for a full days use under average conditions.

The following is a rough guide based on an average usage of 5% transmit, 5% receive and 90% standby.

TRANSMIT POWER	BATTERY LIFE (APPROX)
High (5 watt)	14 hours
Low (1 watt)	24 hours

Battery low alert

As the battery voltage is depleted the internal segments of the battery icon will extinguish one by one. When the last segment is extinguished the remaining battery outline will flash to indicate the battery level is low. You should recharge the battery pack as soon as possible.



If you need to continue using your radio when the battery indicator is flashing, you can extend the life by selecting Low Transmit power.

Cycling your battery pack

Cycling of the Li-ion battery is not necessary.

Conserving battery power

For further information on conserving battery power, see 'Conserving Battery Power' on page 38.

To attach the belt clip

1. Position the clip on radio.
2. Press down on the clip and slide backwards.

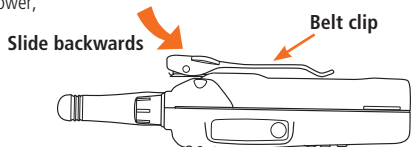

To remove the belt clip

1. Lift the small catch.
2. Press down on the clip and slide forwards.

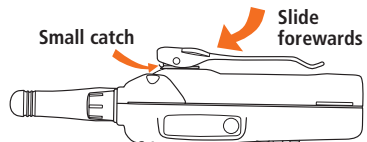

GENERAL OPERATION

POWER ON/OFF

Rotate the volume control clockwise past the 'click' to turn the TX6500S on. Rotate the control fully counter clockwise past the click to turn the radio off.

ADJUSTING THE VOLUME

While receiving a signal, rotate the volume control to achieve a comfortable listening level. If there are no signals present, briefly press the **Squelch** key to open the Squelch then adjust the volume while listening to the receiver's background noise. When finished, briefly press the **Squelch** key again to return the receiver to the quiet state.

NOTE: The minimum setting of the volume control has been factory preset, so even with the volume turned right down, you can still safely listen to an incoming signal with your ear against the speaker (telephone style). The minimum level can be adjusted through the Menu.

DISPLAY LIGHTING

The LCD backlighting activates automatically whenever a key is pressed and turns off automatically after about 5 seconds.

RECEIVING SIGNALS

NOTE: Your radio may be programmed with options that affect the way it behaves when it receives a call from another radio.

Receiving signal

While the radio is not receiving signals, it will remain in standby mode to conserve battery power. When a signal is received under normal conditions, the LED indicator on the upper edge of the radio will light Green and the  icon will appear on the display. Adjust the volume control for a comfortable listening level. Once no further signals are received, the unit will return to standby mode.

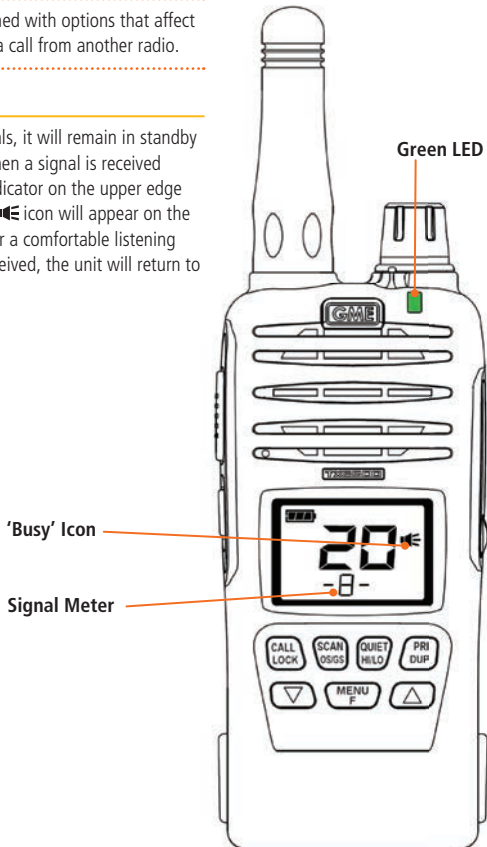

Busy indicator

Whenever the channel is busy the  icon will appear on the display and the LED on the top of the radio will light. However, depending on the muting options set in your radio you may not always hear any sound from the speaker. This can happen when others are sharing the channel but their calls are not meant for you. For this reason it is important to check whether the channel is busy BEFORE transmitting to ensure you do not accidentally talk over someone else.

SIGNAL STRENGTH METER

The TX6500S has a digital signal strength meter that is displayed on the LCD. When in the normal receive mode the received signal strength is displayed as numbers from 0 to 9+ (with 9+ being the strongest) immediately below the channel display.

TRANSMITTING

Before transmitting, check to see if the channel is already in use (the  icon will be displayed and the LED on the top of the radio will be Green). If the channel is busy, you should wait until it is clear before transmitting.

To transmit, press the Push-To-Talk (**PTT**) on the left side of the radio. Hold the radio about 5 – 8 cm from your face with the antenna vertical and speak into the built-in microphone located to the left of the speaker. When talking, speak at a normal voice level. The microphone is quite sensitive so it is not necessary to raise your voice or shout.

When you have finished speaking, release the **PTT** to receive incoming signals (it is not possible to transmit and receive at the same time). If no further signals are received, the unit will revert to standby mode.

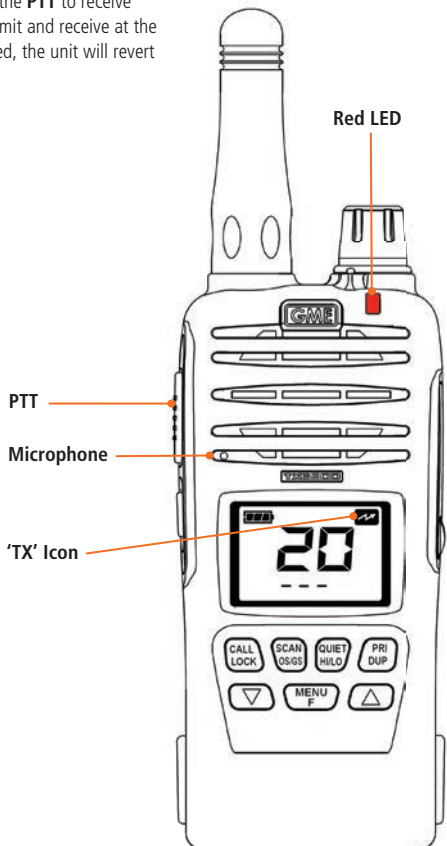

SQUELCH

The Squelch is used to eliminate any annoying background noise when there are no signals present. The TX6500S features a preset Squelch system. The Squelch level has been preset to provide optimum performance in most situations but can be adjusted through the Menu.

The Squelch can be opened or closed with the **Squelch** key. When the Squelch is open the receiver's background noise can be heard, the  Icon is displayed and the Indicator LED glows GREEN.

When the Squelch is closed, the radio remains quiet when there are no signals present but any incoming signals will override the Squelch and be heard in the speaker.

To Open the Squelch

Briefly press the **Squelch** key. A low beep will be heard. If there are no signals present you will hear the receiver's background noise.

To Close the Squelch:



Briefly press the **Squelch** key again. A high beep will be heard and the receiver will become quiet.

NOTE: If an incoming signal is very weak and is close to the minimum Squelch level, it may become broken or 'chopped' by the Squelch action. In this case, simply open the Squelch using the **Squelch** key to allow the signal to be heard clearly.

Squelch settings

The Squelch setting adjusts the sensitivity of the Squelch to incoming signals. The level can be preset to suit your operating environment. The TX6500S has nine preset Squelch sensitivity settings (SQL-1 to SQL-9).

To adjust the Squelch settings:

1. Press and hold the  key until the radio beeps. SQL-X will be displayed where 'X' is a value from 1 to 9.
2. Press the  or  keys to select a suitable Squelch value.

SQL-1: minimum squelch

Allows the Squelch to open on very weak signals. Most suitable for quiet country or rural locations where there are few weak unwanted signals and little locally generated interference.





SQL-9: maximum squelch

The Squelch will open only on very strong signals and weak signals will not be heard. Most suitable for inner city applications where there is severe interference and strong local signals.

For normal operation, select **SQL-3** as a starting point and increase or decrease as necessary to minimise the effects of interference.

3. Press the **PTT** to exit the Menu.



SELECTING CHANNELS

To change channels, briefly press the  key to step up one channel or the  key to step down one channel. Holding either  or  will cause the radio to step through the channels automatically at a faster rate.

PRIORITY CHANNEL

The Priority channel feature allows you to store any channel as a priority channel that can be instantly recalled at the press of a key. This can be used to provide instant access to your working channel, your local repeater channel or any other favourite channel.

To store the Priority channel

1. Select the required channel using the  or  keys.
2. Press and hold the  key. The channel number will flash for a moment then a high beep will be heard as the selected channel is stored.

To recall the priority channel:

1. Briefly press the  key. The TX6500S will immediately switch to the Priority channel accompanied by a high beep.

TIME-OUT TIMER

The radio has a built-in time-out timer that automatically limits transmissions to a maximum of 3 minutes of continuous operation. This feature is required by the ACMA to prevent accidental blocking of the frequency should your **PTT** become jammed or be otherwise pressed accidentally.

When the time-out timer activates, the transmission will stop, the radio will emit a long beep and the  symbol will flash continuously. Normal operation will be restored once the **PTT** is released.





SILENT SQUELCH TAIL

The Squelch tail is the short burst of noise that is heard in the speaker at the end of a transmission before the Squelch closes.

To some it is a reassuring confirmation that it is their turn to transmit but in some applications it may be an annoyance especially when listening through an earpiece or headphones.

The Silent Squelch Tail function removes this Squelch tail, reducing it to a faint click as the Squelch closes.





To enable or disable the Silent Squelch Tail:

1. Press and hold the  key to enter the Menu.
2. Press the  key repeatedly until 'SSTxx' is displayed (where xx = ON or OF).
3. Press the  key to enable the Silent Squelch Tail. SSTON will be displayed and the Squelch tail will now be silent.
4. Press the  key to disable the Silent Squelch Tail. SSTOF will be displayed and the Squelch tail will be restored.
5. Press the **PTT** to exit the Menu.

KEY BEEPS

The Key Beeps provide audible feedback whenever the keys are pressed.

To set the key beep volume level.





1. Press and hold the  key until the radio beeps.
2. Press the  key repeatedly until 'BEEPx' appears (where x is a value from 0-9).
3. Press the  key to increase the beep level or the  key to decrease the beep level. The minimum audible level is 'BEEP1' and the maximum level is 'BEEP9'.
4. To disable the keypad beeps select 'BEEP0'.
5. Press the **PTT** to exit.

VOICE SCRAMBLER

Your radio incorporates a simple voice scrambler using band inversion. The scrambler is compatible with other GME radios and with the majority of scramblers used by other manufacturers, allowing you to enjoy scrambled communications with owners of both GME and non-GME radios.

Once the scrambler has been activated your transmission and reception will only be intelligible to others using the same scrambler technology.





To enable or disable the voice scrambler:

1. Press and hold the  key to enter the Menu.
2. Press the  key repeatedly until 'ENCxx' is displayed (where xx = ON or OF).
3. Press the  key to enable the scrambler encoder. ENCON will be displayed.
4. Press the  key to disable the scrambler encoder. ENCOF will be displayed.
5. Press the **PTT** to exit the Menu.

MINIMUM VOLUME

When the volume control is adjusted to minimum there is still sufficient volume to be heard in a quiet environment. This minimum volume level can be adjusted.

To adjust the Minimum Volume





1. Press and hold the  key until the radio beeps.
2. Press the  key repeatedly until 'VMINx' appears (where 'x' is a value from 1 – 9).
3. Press the  key to increase the value or press the  key decrease the value. A higher value results in a higher level of minimum volume.

TIP: If there are no signals present to help with the minimum volume adjustment, briefly press the Squelch key to open the Squelch. You can then adjust the minimum volume while listening to the receiver noise.

NOTE: There will always be some audible output at the minimum volume setting even when VMIN is set to the lowest value. It is not possible to set the minimum volume to 0.

DISPLAY CONTRAST

To adjust the Display Contrast



1. Press and hold the  key until the radio beeps.
2. Press the  key repeatedly until 'CONTx' appears (where 'x' is a value from 1 – 9).
3. Press the  key to increase the contrast or press the  key decrease the contrast.

DYNAMIC VOLUME CONTROL (DVC)

The modulation levels of signals heard on the UHF CB band may vary considerably resulting in noticeable differences in received audio volume between stations. Generally users have compensated for this by adjusting the Volume control for each incoming signal. With the introduction of 80 channel narrowband transmissions, the variation in received audio volume caused by the mixture of wide and narrow band signals has increased further.



Your radio has a unique GME feature called Dynamic Volume Control that is able to automatically compensate for these variations in received audio level. When activated, this feature automatically adjusts the received audio level resulting in a constant audio output level to the speaker.

To enable Dynamic Volume Control

1. Press and hold the  key to enter the Menu.
2. Press the  key repeatedly until 'DVCxx' is displayed (where xx = ON or OF).
3. Press the  key to enable the Dynamic Volume Control. DVCON will be displayed.

4. Press the  key to disable the Dynamic Volume Control. DVCOF will be displayed.
5. Press the **PTT** to exit the Menu.

FUNCTION KEY

The  (Function) key is used to access the secondary functions marked in Red on the four keys immediately below the LCD. To select a secondary function, briefly press the  key ('F' will be displayed) then immediately press the key labelled with the required function. If no secondary key is pressed within 10 seconds, the radio will return to normal operation.

The following secondary functions are available.

LOCK (Keypad Lock)



OS/GS (Open/Group Scan)



HI/LO (TX Power)

DUP (Duplex)

KEYPAD LOCK



The  key is used to lock the keypad to prevent unintentional key presses from altering your TX6500S's settings. While the keys are locked, only the **PTT**, **On/Off Volume** control, **LOCK** and **Squelch** keys continue to function. If any other key is pressed while the keypad is locked, 'LOCK' is displayed.

To lock the keys, briefly press the  key followed by the  key. A high beep will be heard and 'LOCK' will appear on the display for several seconds. The keypad will now remain locked even if the radio is switched off and on again.

To unlock the keys and restore them to normal operation, briefly press the  key followed by the  key. A low beep will be heard and 'UNLOCK' will be displayed for a few seconds.

OS/GS KEY

The  key is used to select a scan group for scanning. Available scan groups are Open scan (OS), Group scan (GS) or Network scan (NETWK).



To cycle between Open scan, Group scan or Network scan, briefly press the  key followed by the  key. 'OPEN', 'GROUP' or 'NETWK' will be displayed briefly.

Please refer to the SCANNING section for further details on the operation of each scan group.

NOTE: Network scan is disabled by default and if required, will need to be enabled through the Menu.

HI/LO POWER

The  key is used to switch the transmitter power from its maximum level of 5 watts down to 1 watt. Using low transmitter power for short range communications will conserve battery power. If you need to get the maximum use between charges and you spend a fair proportion of the time transmitting then selecting low power can increase battery life quite dramatically.

Briefly press the  key followed by the  key. A high beep will indicate High power is selected and a Low beep indicates Low power is selected. When Low power is selected, 'LO' is displayed.

DUPLEX

Duplex operation allows the TX6500S to operate through repeaters. Repeaters automatically re-transmit your signal over a wider area, providing greatly increased range.

Simplex/Duplex Range Comparison

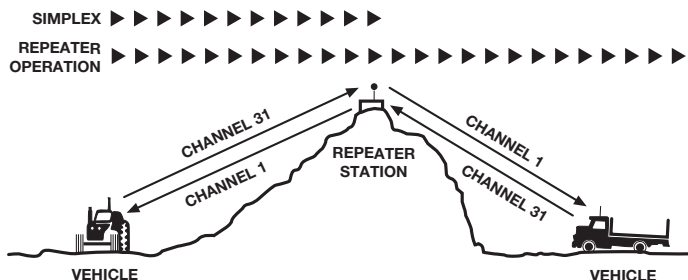

The Duplex function operates only on designated repeater channels. These are channels 1 – 8 and 41 – 48. When Duplex is selected on one of these channels, the TX6500S will receive on the selected channel but will transmit 30 channels higher. i.e if channel 1 is select the TX6500S will receive on channel 1 but transmit on channel 31. See the table below.

Channel Selected	1	2	3	4	5	6	7	8	41	42	43	44	45	46	47	48
Receive Channel	1	2	3	4	5	6	7	8	41	42	43	44	45	46	47	48
Transmit Channel	31	32	33	34	35	36	37	38	71	72	73	74	75	76	77	78

The TX6500S allows you to select duplex operation individually on each channel. This allows you to select Duplex only on repeater channels that are allocated in your area while the rest can be used for normal simplex or direct radio-to-radio communications.

To select Duplex on a repeater channel

1. Select the required channel 1 – 8 or 41 – 48.
2. Briefly press the **MENU/F** key followed by the **PRI/DUP** key. will appear on the display accompanied by a high beep.

To remove Duplex from a channel

1. Select the required channel 1 – 8 or 41 – 48. will be visible on the display.
2. Briefly press the **MENU/F** key followed by the **PRI/DUP** key. will disappear from the display accompanied by a low beep.

SCANNING







OVERVIEW

The TX6500S is provided with a Scan function to allow groups of user programmable channels to be scanned for signals. Channels can be scanned at up to 40 channels per second. When a signal is found, scanning will pause to allow the signal to be heard and will resume scanning when the channel is clear again.

SCAN GROUPS

The TX6500S features three scan groups – Open Scan, Group Scan and Network Scan.

To quickly determine which channels are currently programmed into the selected scan group.

1. Select the required scan group (press  followed by the  key). 'OS', 'GS' or 'NETWK' will be displayed.
2. Briefly press the  key. 'F' will be displayed.
3. Press the  or  keys to step through the channels. Only channels that are stored in the memory of the selected scan group will be displayed.
4. When finished, press the  key to exit.

OPEN SCAN

Open Scan allows any of the channels to be scanned for activity in an ascending sequence (i.e. from the lowest channel to the highest). If a busy channel is found, scanning will pause to allow the signal to be heard. Once the channel has been clear for 5 seconds, scanning will resume automatically.

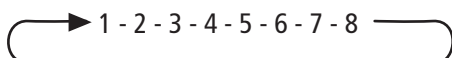

e.g. Scanning channels 1 – 8 in Open Scan.









Selecting Open Scan

Briefly press the  key then the  key until 'OPEN' is displayed.

Programming Scan channels

Your radio has all 80 channels factory-programmed into the Open Scan memory. Any channels not required can be removed.

To add or remove channels from the Open Scan memory:

1. Check that the radio is not already scanning. If it is, briefly press the  key to stop the scan function.
2. Select the required channel using the  or  keys.
 - If the channel is currently in the scan memory  will be visible above the channel display. To remove the channel, hold the  key until a low beep is heard.  will disappear indicating the channel is no longer in memory.
 - If  is not visible above the channel display, the selected channel is not in the scan memory. To add it, hold the  key for a few seconds until a high beep is heard.  will appear to confirm the channel is now in memory.



Repeat step 2 to add or remove other channels in the scan memory.

To scan

To start scanning, briefly press the  key. A high beep will be heard and the  icon will animate.

NOTE: If there is only one channel programmed into the Open Scan memory, a long low beep will be heard when you press the  key and the command will be ignored.

Operating in the Open Scan mode

- If a busy channel is located, scanning will pause to allow the signal to be heard and will remain there for as long as the channel remains busy. Once the channel has been clear for 5 seconds, scanning will resume automatically.
- If your radio has paused on a busy channel;
 - i. Briefly press the  or  keys to skip over that channel and resume scanning from the next channel in the sequence (see **Auto Skip** for more skip options)
or
 - ii. Briefly press the  key to exit the Scan mode and remain on the busy channel.

- To transmit while scanning, press the **PTT**
 - If the radio is scanning when the **PTT** is pressed, the scan will pause and the radio will transmit on the working channel (the working channel is the last-selected channel). You can now converse on that channel in the usual way. Once the channel has been clear for 5 seconds scanning will resume.
 - If the radio was paused on a busy channel, it will transmit on that channel and that channel will then become the working channel. You can now converse on that channel in the usual way. Once the channel has been clear for 5 seconds scanning will resume.
- If your radio is scanning and you need to use your Priority channel (for an urgent call or an emergency), briefly press the  key. The scan will be cancelled and the radio will jump straight to the Priority channel.

GROUP SCAN

Group Scan allows you to scan a number of channels for activity while also monitoring your Priority channel. The receiver will scan the other channels **ONLY WHILE THERE ARE NO SIGNALS ON THE PRIORITY CHANNEL**. If a signal appears on the priority channel it will override any signals being received on any of the other channels. In addition, if you press the **PTT** at any time, the radio will transmit on the priority channel in the usual way.

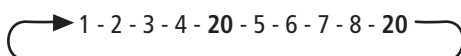

e.g. Scanning channels 1 – 8 with Priority Channel 20 in Group Scan









Selecting group scan

Briefly press the  key then the  key until 'GROUP' is displayed.

Programming Group Scan channels

The Group Scan memory is empty by default so you will need to add channels to it before use.

To add or remove channels from the Group Scan memory:

1. Check that the radio is not already scanning. If it is, briefly press the  key to stop the scan function.
2. Select the required channel using the  or  keys.
 - If  is not visible above the channel display, the selected channel is not in the scan memory. To add it, hold the  key for a few seconds until a high beep is heard.  will appear to confirm the channel is now in memory.
 - If the channel is currently in the scan memory  will be visible above the channel display. To remove the channel, hold the  key until a low beep is heard.  will disappear indicating the channel is no longer in memory.
3. Repeat step 2 to add or remove other channels in the Group Scan memory.

To Scan

To start scanning, briefly press the  key. A high beep will be heard and the  icon will animate.

NOTE: If there are no channels programmed in the Group Scan memory when you press the  key, a low beep will be heard and the command will be ignored.



Operating in the Group Scan mode

In Group Scan mode, the TX6500S scans all the channels programmed into the Group Scan memory with the priority channel being scanned after every fifth channel.

Receiving in the Group Scan mode

If a signal is heard on a scanned channel, scanning will pause on that channel and remain there for as long as the channel is busy, and for 5 seconds after the channel has cleared, as long as there are no signals on the priority channel. During this time the receiver will continue to check the priority channel for signals every 2 seconds, resulting in a series of small 'breaks' in the reception of the 'paused' channel. If no signals are heard after 5 seconds, the radio will resume scanning.

If a signal appears on the priority channel at any time (even when paused on a scan channel) the receiver will switch straight to the priority channel and will stay there for as long as the channel is busy. During this time you can transmit on the priority channel in the usual way. Once there has been no activity on the priority channel for 5 seconds, the radio will resume scanning the other channels.



If your radio pauses on a busy channel and you don't wish to listen to that conversation, briefly press the  or  key. The radio will skip over that channel and resume scanning from the next channel in the sequence (see **Auto Skip** for more skip options).

Transmitting in Group Scan mode



To transmit on the priority channel, simply press the **PTT AT ANY TIME**. The radio will switch straight to the priority channel. When you have finished your conversation and there has been no further activity on the priority channel for 5 seconds, the radio will resume scanning the other channels. To transmit on any other group scan channel, you must exit the scan mode, select the required channel then talk in the usual way.

When your conversation is finished, press the  key to resume scanning.

AUTO SKIP

While scanning, if a busy channel in your scan group becomes a nuisance by constantly interrupting the scan, briefly press the  or  key. The radio will skip over the busy channel and temporarily remove it from the scan group for 30 seconds to allow time for the channel to become clear again. Scanning will then continue from the next channel in the sequence. After 30 seconds the skipped channel will be reinstated in the scan sequence.

TIP: You can use this method to temporarily remove as many busy channels from the scan group as required. Note however that if you attempt to skip the last remaining channel, all the previously skipped channels will be restored to the scan group.

If the unwanted busy channel continues to interrupt the scan even after the 30 second skip period has elapsed, hold the  key while the radio is paused on that channel. The 'nuisance' channel will be completely removed from the scan group for the duration of that scan session. To restore the channel, simply stop and restart the scan session using the  key (or switch the radio Off then On again).



TIP: You can use this method to remove multiple busy channels from the current scan session as required. Note however that if you attempt to remove the last remaining channel, all the previously removed channels will be restored to the scan group.

NOTE: In Group Scan mode you can also treat the Priority Channel as a nuisance channel and remove it from the scan session if you wish, but if you do, you will no longer be monitoring the Priority Channel while scanning. However if you press the **PTT** you will still be taken straight to the Priority Channel when required to allow you to converse on that channel. After your conversation has finished the scan will continue without the Priority Channel included.

ADDITIONAL OPEN/GROUP SCAN OPTIONS

There may be applications where you have no need for the priority channel and would prefer to have two Open Scan groups with different channels in each. Alternately you may prefer to have two Group Scan groups with different priority channels in each.

Your TX6500S can be Dealer-programmed to convert the Open Scan/Group Scan functions into two Open Scans or two Group Scans. If you would prefer this feature to the default option you should contact your GME Dealer to arrange for this feature to be enabled.

When two Open Scan modes are enabled they are displayed as OPEN1 and OPEN2. When the two Group Scan modes are enabled they are displayed as GRP1 and GRP2. To select the required scan mode briefly press the  key followed by the  key to cycle through the available scan groups until the required scan mode is displayed.

NOTE: Once the scan groups have been altered by your Dealer, they become a permanent part of the TX6500S's features, replacing the standard Open Scan/Group Scan options. If you find later that you need the original Scan functions re-enabled, you will need to return your TX6500S to your Dealer for reprogramming.

NETWORK SCAN (NET-SCAN)





Net-Scan allows a group of radio users to maintain communications even when the band is congested. To achieve this, all members of the Net-Scan group must share a common CTCSS/DCS code and a common set of scan channels. Once activated, Net-Scan's intelligent scanning software keeps track of clear channels within your scan group. When any member of the group transmits, their radio automatically selects a clear channel to transmit on. Other radios scanning in the same Net-scan group will lock onto that channel allowing all members of the group to join the conversation. If a signal from outside your Net-Scan group appears on the chosen channel (either with no code or the wrong code), the group will automatically switch to a new clear channel at the next transmission. In this way the group can continue to communicate with minimal interference to or from other users.

Enabling Net-Scan

Net-Scan is normally switched off by default but can be enabled through the Menu.

NOTE: When you enable Net-Scan you must also choose a suitable CTCSS or DCS tone to be used by your Net-Scan group. All members of your Net-Scan group must use this same code.

To enable Net-Scan;

1. Hold the  key until the radio beeps. The radio will enter the Menu mode.
2. Briefly press the  key repeatedly until 'NS-OF' is displayed.
3. Press the  key to enable Net-Scan then continue pressing the  or  keys to select a suitable CTCSS or DCS tone.
 - CTCSS tones for Net-Scan are labelled NS-01 – NS-50.
 - DCS tones for Net-Scan are labelled NS001 – NS104.



e.g. Netscan CTCSS tone 50

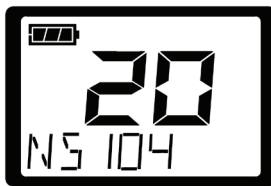



e.g. Netscan DCS tone 104

4. When the required CTCSS/DCS tone is displayed, press the **PTT** or hold the  key to exit. Note: Selecting CTCSS/DCS tones for Netscan operation does not affect the Global CTCSS/DCS tone setting used for normal CTCSS/DCS operation.

NOTE: Selecting CTCSS/DCS tones for Netscan operation does not affect the Global CTCSS/DCS tone setting used for normal CTCSS/DCS operation.



Selecting Net-Scan

When Net-Scan is enabled, a new Network Scan option becomes available on the  key. To select the Network Scan option, press the  key followed by the  key to cycle through the available scan groups until 'NETWK' is displayed. The radio is now in the Network Scan mode.

Programming channels into Net-Scan









All radios in your Net-Scan group must have the same channels programmed into their Net-Scan memory. Your radio's Net-Scan memory has already been factory programmed with 43 of the available 80 channels. The remaining 37 channels, which consist of the 32 repeater input/output channels, 2 telemetry channels and 3 reserved channels, have not been included to minimise the risk of interference to other services on these channels.

To quickly determine which channels are currently programmed into the Net-Scan group.

1. With the NETWORK scan group selected, briefly press the  key. 'F' will be displayed.
2. Press the  or  keys to step through the channels. Only channels that are stored in the Net-Scan memory will be displayed. Take a note of the channel number to compare with the other radios in your Net-Scan group.

When finished, press the  key to exit.

To add or remove Net-Scan channels

1. With Net-Scan mode enabled, select the require channel using the  or  keys.
 - If the channel is currently in the Net-Scan group the  icon will be visible above the channel display. To remove the channel, hold the  key until a low beep is heard.  will disappear indicating the channel is no longer in memory.
 - If the  icon is not visible above the channel display, the selected channel is not in the Net-Scan memory. To add it, hold the  key until a high beep is heard.  will appear to confirm the channel is now in memory.

Repeat step 1 to add or remove further Net-Scan channels.

IMPORTANT: When adding channels to Net-Scan, please consider the following:

The transmitter on your radio is inhibited on channels 22, 23 and channels 61, 62, 63 as required by the ACMA. These channels are therefore unsuitable for use as Net-Scan channels.

You should only include a repeater channel AFTER you have confirmed that the channel is not allocated to a repeater in your area. If you inadvertently include an active repeater channel in your Net-Scan, you or others in your Net-Scan group may cause interference to other repeater users on that channel.

Starting Net-Scan

With Net-Scan mode enabled, press . The radio will begin scanning and 'NSxxx' (where xxx is the selected CTCSS or DCS tone) will be displayed.



Using Net-Scan

When a member of the group initiates a transmission their radio will automatically select a clear channel to transmit on. Other radios scanning in the same Net-Scan group will locate the transmission containing the groups CTCSS/DCS code and open their Squelch allowing the transmission to be heard across the entire group. When the transmission ends, the other radios in the group will immediately resume scanning.



Any member of the group who responds to the initial transmission will automatically re-use the same channel as long as the channel remains free of other signals. This allows the radios in the group to respond more quickly to further transmissions from others in the group.

If a signal from outside your Net-Scan group appears on the channel (either with no code or the wrong code), the channel will be discarded and a new clear channel selected at the next transmission. The other radios in the group will then locate the new channel allowing the conversation to continue seamlessly without any input from the user.

Ending the Scan

To stop scanning, briefly press the  key. A low beep will be heard and the animated  icon will stop. As long as the radio was not on a busy channel, it will return to the last channel you selected, otherwise it will stay on the busy channel.

USING THE PRIORITY CHANNEL WHILE SCANNING

If your radio is scanning in Open Scan or Net-Scan mode and you need to use your Priority channel (for an urgent call or an emergency), briefly press the  key. The scan will be cancelled and the radio will jump straight to the Priority channel. When your conversation has finished, press the  key to continue scanning.

If your radio is scanning in Group Scan mode simply press the **PTT**. The radio will automatically transmit on the priority channel. When your conversation has finished, the radio will resume scanning 5 seconds after the channel has become clear.

SELCALL

Your TX6500S has a Selective Calling (SelCall) system that operates like a telephone. Each radio is pre-programmed with its own unique SelCall number. If this number is called by another radio, your TX6500S will beep to alert you.

Your radio also features a Quiet function that prevents unwanted signals from being heard in the speaker. If you do not want to hear any other activity while on a channel, simply push the  key. The radio will then remain quiet to all incoming signals until your SelCall number is called.

SELCALL IDENTIFICATION NUMBER (IDENT)

Your TX6500S is factory programmed with its own unique SelCall Identification Number (otherwise known as an Ident). This number identifies your radio from others in your area. Each time you switch your TX6500S on your SelCall Ident is displayed briefly at the bottom of the LCD. You should make your Ident known to anyone who may need to call you using SelCall. If your TX6500S hears a SelCall signal, it will compare the incoming Ident with its own. If there is a match, your radio will sound an alarm to alert you to the call.

THE QUIET MODE (Q)

The QUIET mode works with the SelCall function to ensure the radio remains quiet to all incoming signals UNLESS it receives its own SelCall Ident. In this way, your radio can monitor a busy channel without disturbing you, but still let you know when you are being called. When QUIET mode is set, you may see the  icon appear on the display indicating the channel is in use but nothing will be heard in the speaker.

The QUIET mode can be enabled on individual channels allowing you to freedom to choose which channels will remain quiet and which will stay open to all incoming signals. Once your SelCall Ident is received, an alarm sounds and the QUIET mode is cancelled allowing you to converse normally on the channel.

NOTE: You don't need to set the QUIET mode to use SelCall. If you prefer to listen to all incoming conversations you can still receive SelCalls on any channel even if the QUIET mode is not set.

SELCALL MEMORIES

Your TX6500S is fitted with 10 SelCall memories which can be used to store frequently used SelCall Idents.

To access the SelCall memories briefly press the **CALL LOCK** key. The radio will display the SelCall Ident that was last sent. This is where you will enter the SelCall Ident of the radio you wish to call manually.

Press the **▲** key repeatedly to step upwards through the 10 SelCall storage memories labelled c0 – c9. Press the **▲** key again to select the final memory location labelled **id**. This location holds your radio's own SelCall Ident. Each location can be edited as described further below. Press the **▲** key again to return to storage memory **c0**.

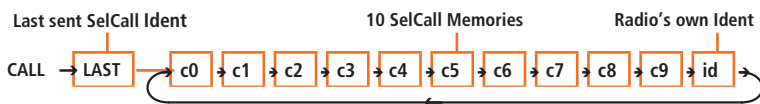

IDENT OR ALPHA NAME

SelCall Idents stored in memory can be allocated a 5 letter 'Alpha' name. The name is stored into memory along with the SelCall Ident. If an incoming SelCall matches one of those in your radio's memory, your radio can be set to display the name instead of the Ident. This makes for easier identification of the calling radio.



SelCall Ident

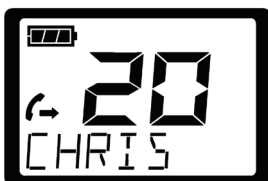

Alpha Name

To switch between the Ident and Alpha modes briefly press the **SCAN 0605** key followed by the **Squelch** key. A high beep indicates the Ident mode is selected while a low beep means the Alpha mode is selected.

NOTE: If the selected Ident has not been named, '--- --' will be displayed while in Alpha mode.

IMPORTANT: Before entering a SelCall Ident, your radio must be in the Ident mode. If your radio displays text instead of numbers, it is in the Alpha mode – briefly press the **Squelch** key to switch back to the Ident mode. A high beep indicates Ident mode is selected while a low beep means the Alpha mode is selected.





SENDING A SELCALL

1. Press the **CALL LOCK** key. **↶** is displayed, along with the SelCall Ident that was last sent.
2. Enter the required SelCall Ident as follows:
 - a. Hold the **MENU F** key until a beep is heard. The right hand digit of the SelCall Ident will flash.
 - b. Press the **▲** or **▼** keys to select the required number in the flashing digit position.
 - c. Briefly press the **MENU F** key again to select the next digit position.
 - d. Repeat steps (b) and (c) to enter all 5 digits as required.
 - e. When the desired SelCall Ident is displayed, press and hold the **CALL LOCK** key until the **📡** icon appears. The SelCall will be sent.





Call acknowledge

If your SelCall transmission was successful, the radio you called should respond with a call-acknowledge alert – usually two quick beeps. This will confirm to you that the radio you called is now alerting its user to your signal. If the call-acknowledge is not received the other radio may be out of range or on a different channel.







To SAVE a SelCall Ident to memory

1. Press the  key.  is displayed, along with the SelCall Ident that was last sent.
2. Press the  or  keys to select the Ident memory that you wish to programme (locations c0 to c9).



3. Enter the SelCall Ident as follows:

- a. Hold the  key until a beep is heard. The right hand digit of the SelCall Ident will flash.
- b. Press the  or  keys to select the required number in the flashing digit position.
- c. Briefly press the  key again to select the next digit position.
- d. Repeat steps (b) and (c) to enter all 5 digits as required.
- e. Now press and hold the  key. The entire Ident will flash for a few seconds then the radio will beep as the new Ident is stored.





To RECALL and SEND a SelCall Ident from the memory

1. Press the  key.  is displayed, along with the SelCall Ident that was last sent.
2. Press the  or  keys to select the Ident memory that you wish to recall (locations c0 to c9).
3. With the required SelCall memory displayed, press and hold the  key until the  icon appears. The SelCall will be sent.

To RESEND the last RECEIVED SelCall Ident

1. Press and hold the  key until the  icon appears. The SelCall that was last received will be sent.

To RESEND the last SENT Ident

1. Press the  key briefly.  is displayed, along with the SelCall Ident that was last sent.
2. Press and hold the  key until the  icon appears. The SelCall that was last sent will be re-sent.

ADDING ALPHA NAMES TO SELCALL IDENTIS

SelCall Identis stored in memory can be named using a 5 letter Alpha name. The name is stored into memory with the SelCall Ident. If an incoming SelCall matches one of those in your radio's memory, the Alpha name can be displayed instead of the SelCall Ident.



Available characters

The following characters are available for use in naming your SelCall Identis.

PUNCTUATION	NUMBERS	LETTERS
- + \ SPACE	1 2 3 4 5 6 7 8 9 0	A B C D E F G H I J K L M N O P Q R S T U V W X Y Z

Displaying Alpha names

To display the Alpha name of an incoming SelCall your radio must be in Alpha mode. To switch between the Alpha mode and the Ident mode;

1. Briefly press the  key.  is displayed.
2. Briefly press the **Squelch** key to toggle between Ident and Alpha modes. A high beep indicates Ident mode is selected (numbers are displayed) while a low beep means the Alpha mode is selected (text is displayed).

Briefly press the  key again to exit or simply wait until the Call function times out.

NOTE: Except when displaying a SelCall Ident, there is nothing on the display to indicate whether the Ident or Alpha mode is selected. The selected mode will only become obvious when Idents are being displayed.

Storing an Alpha name

Before adding an Alpha name, first save the required Ident to memory as described above.

1. Briefly press the **CALL LOCK** key. **↔** is displayed along with the last sent SelCall.
2. Press the **Squelch** key if necessary to select the Alpha mode.
3. Press the **▲** or **▼** keys to select the memory you wish to recall (locations **c0** to **c9**). If no Alpha name has been saved for that memory '--- -- --' will be displayed otherwise the name that was last programmed into that memory will be visible.
4. Enter the name as follows:
 - a. Hold the **MENU F** key until a beep is heard. The left hand character of the name will flash.
 - b. Press the **▲** or **▼** keys to change the character in the flashing character position (see table below for available characters).

TIP: Hold the **▲** or **▼** key for a few seconds to step quickly through the available characters.

- c. When the correct character is displayed, briefly press the **MENU F** key to select the next character position.
 - d. Repeat steps (b) and (c) to program all 5 characters as required.
5. To store the name, hold the **MENU F** key until a beep is heard. The name will flash for a few seconds then the radio will beep.

Repeat the procedure to add Alpha names to other stored SelCall memories.

To exit the **CALL** mode, briefly press the **CALL LOCK** key. The radio will return to normal operation.

Once you have names programmed into your SelCall memories, you can leave the radio in Alpha mode so that any incoming SelCalls that match those in the memory will display the associated name instead of the Ident. Incoming SelCalls that do not match those in the memory will simply display the Ident in the usual way.

RECEIVING SELCALLS

When someone calls your radio using SelCall, it will beep to alert you to the call. In addition, it will cancel the **QUIET** mode (if selected) and display the Ident or name of the caller.

The SelCall alert



When your TX6500S receives its own SelCall Ident, an alarm will sound in the speaker. Initially the alarm will beep urgently for around ten seconds then the beeps will reduce to around one every four seconds. During this time the radio will remain in the **↔** mode with the callers Ident or Alpha name displayed. To switch between the SelCall Ident and the ALPHA name, briefly press the **CALL LOCK** key followed by the **Squelch** key.

Responding to a SelCall alert

To cancel the alarm but leave the incoming SelCall Ident on the display:

- Briefly press the **QUIET HILO** key. The alarm will stop beeping but the caller's Ident/Name will remain on the display and the channel will remain open to any incoming signals. This feature is useful if you are currently busy but intend to call the person back later.

To return the call

- Press and hold the  key for a few seconds until the  icon appears. The 'callers' SelCall will be sent back to the caller to let them know you are now available.

To cancel the alarm completely and talk on the channel

- Press the **PTT** button and talk in the usual way. The alarm will be cancelled, the display will return to normal and the channel will be open for normal communication.

Call acknowledge signal

When your TX6500S receives its own SelCall Ident, it automatically responds by transmitting an 'acknowledge' signal back to the caller. This informs the caller that their SelCall transmission has been successful and that your radio is alerting you to their call. The 'acknowledge' signal is heard at the caller's end as two quick beeps.

QUIET MODE

The QUIET mode mutes the TX6500S's receiver to prevent any incoming signals from being heard in the speaker until your SelCall Ident is received. This allows you to monitor a busy channel for personal calls without being disturbed by unwanted signals.



If your SelCall Ident is received, the QUIET mode is cancelled and all incoming signals are heard in the speaker.

Setting up the QUIET mode



To setup the QUIET mode you must first 'tag' the channels that you want to stay Quiet. Once your selected channels are tagged, you can activate the QUIET mode. Once activated, the channels you have tagged will remain Quiet to all incoming signals (unless your SelCall Ident is received). Channels that were not tagged will be open to all signals and will continue to operate normally.



To tag a channel for QUIET operation

Select the required channel using the  or  keys.



Press and HOLD the  key until a high beep is heard.  will appear above the channel display indicating the selected channel is now tagged for Quiet operation.

To remove the QUIET tag from a channel:

Use the  or  keys to select a channel that has been tagged.  will be visible above the channel display.

Press and hold the  key until a low beep is heard.  will disappear indicating this channel is no longer tagged for Quiet operation.

To activate the QUIET mode

Use the  or  keys to select a channel that has been tagged for Quiet operation (you cannot activate the Quiet mode unless you have selected a 'tagged' channel).  will be displayed.

Briefly press the  key.  will appear on the display. Now all channels tagged for Quiet operation will be operating in the Quiet Mode.

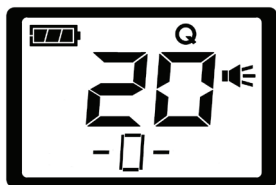



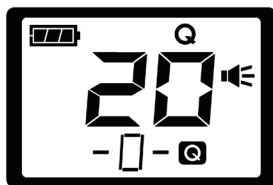

Channel Tagged with 'Q'





Quiet mode enabled

To de-activate the QUIET mode

Select any channel that has been tagged for Quiet operation.  and  will be visible.

Briefly press the  key.  will disappear from the display and all channels tagged for Quiet operation will now be open to all incoming signals.

Receiving signals in the QUIET mode

- If a normal signal is received on a QUIET channel, the channel will appear busy (the  indicator will be visible) but no sound will be heard from the speaker. This means you will not be disturbed by the signal.
- If a normal signal is received on an Open channel (one that is not tagged with  the signal will be heard in the usual way.











If a signal containing your SelCall Ident is received on any channel – Open or QUIET – the QUIET mode will be cancelled and the alarm will beep to alert you to the call. In addition, the callers Ident or ALPHA name will be displayed. All channels will now be open for normal transmission and reception.

SCANNING IN THE QUIET MODE

The TX6500S will allow you to scan while in the QUIET mode. Using this feature you can monitor a group of Quiet channels or a combination of Quiet and Open channels.



NOTE: Your radio cannot receive SelCalls while scanning with Net-scan. If you need to scan in the quiet mode please use either Open or Group scan.

To scan in the QUIET mode

1. Briefly press the  key followed immediately by the  key to select the required Scan group (OS or GS only).
2. Select the channels you wish to scan and hold the  key to store them into memory ( is displayed).
3. From these channels, select the ones you wish to remain Quiet and hold the  key to tag them for QUIET operation ( is displayed).
4. Press the  key. The radio will begin scanning and  will animate on the display.
5. Now, briefly press the  key to activate the QUIET Mode. The  icon will appear to confirm the radio is scanning in the QUIET mode.

Receiving signals while scanning in the QUIET mode

- If a normal signal is received on an open channel, scanning will pause while the channel is busy and will resume 5 seconds after the channel becomes clear. (If you are scanning in Group Scan mode, the radio may switch between the open channel and the Priority channel – this is normal).
- If a normal signal is received on a Quiet channel but your SelCall Ident is not detected, the signal will be ignored and scanning will continue.
- If a signal containing your SelCall Ident is received on any channel (either Open or Quiet), the scanning and QUIET modes will be cancelled and the receiver will stay on that channel. The alarm will then beep to alert you to the call and the callers Ident or ALPHA Name will be displayed. The channel will now be open for normal communications.

NOTE: If the  icon is visible when scanning stops, the channel is a quiet channel. If the  is not visible, the channel is a normal channel.

TIP: To ensure reliable SelCall detection when scanning in the Open Scan mode, it is recommended that you restrict the number of channels in the Scan group to less than 20.

GROUP CALLING

The TX6500S's SelCall system includes a Group Call function which allows you to call up to 10 radios simultaneously. This can be useful in an emergency situation where you may need to transmit a message to a number of radios in your group. To achieve this, the radios you are calling must be programmed with sequentially numbered SelCall Idents where the first 4 digits are the same on each radio. e.g. 12340, 12341, 12342, 12343, --> 12349

The Group Call function works by allowing you to enter a special 'group code' into the last digit position of the SelCall Ident you are sending. The 'group code' appears as an 'A' when displayed in the radio. When this 'group code' is received, it substitutes for any other number in the last digit position. As long as the first 4 digits of the SelCall you are sending match those of the radios you are calling, their SelCall alarm will be activated as if their full 5 digit SelCall Idents had been received.



e.g. Group call to Ident

- Transmitting the SelCall Ident 12341 will only activate the alarm in the radio with the SelCall Ident of 12341.
- Transmitting 1234A will activate the alarms in all radios with Idents 12340 through 12349 (a total of 10 radios).

If the radios in your fleet do not have sequentially numbered SelCall Idents you may be able to reprogram them yourself. Most recent GME radios have this feature (including your TX6500S). If your radios do not allow you to change the SelCall Idents you may need to arrange for your dealer to re-program them for you.

Programming and sending Group calls

The process for entering a Group call Ident is the same as entering a normal SelCall Ident.

1. Press the **CALL LOCK** key. is displayed, along with the SelCall Ident that was last sent or received. If the radio is in the ALPHA mode, briefly press the **Squelch** key to return to the Ident display.
2. Enter the required SelCall Ident as follows:
 - a. Hold the **MENU F** key until a beep is heard. The right hand digit of the SelCall Ident will flash.
 - b. Press the or keys to select 'A' in the right hand flashing digit position. This is the special code that will create the Group Call.
 - c. Briefly press the **MENU F** key again to select the next digit position
 - d. Press the or keys to select the required number in next the flashing digit position.
 - e. Repeat steps (c) and (d) to enter all 5 digits as required. When completed, the first 4 digits of the Ident you have entered will match all the radios in the group and the last digit will be set to 'A'.
3. Once the Ident has been entered you have 5 seconds to send it otherwise the mode will be cancelled and the Ident you entered will be lost. Press and hold the **CALL LOCK** key until the icon appears. The SelCall will be sent.

Call acknowledge in Group mode

There is no call acknowledge after sending group calls. This is to prevent all the radios in your group from trying to respond at the same time.

Receiving Group calls

Receiving a Group call is identical to receiving a normal SelCall except that the alarm sound is a LOW tone beep instead of the normal High tone beep. The Callers Ident or ALPHA Name appears on the display in the usual way.

Storing Group call Idents

Group Call Idents can be stored in memory in the same way as a standard SelCall Ident.

CTCSS & DCS

CTCSS (Continuous Tone Coded Squelch System) and DCS (Digital Coded Squelch) are similar Squelch quieting systems that allow groups of users to share the same channel without disturbing each other. The CTCSS system uses 1 of 50 low frequency tones to open and close the Squelch on the radio. The DCS system is similar to CTCSS but uses 1 of 104 digital codes to control the Squelch.

Your choice of CTCSS or DCS will largely depend on which is currently being used by other radios in your group. If neither system is currently in use, you can make your own choice. There is no difference in performance between the two systems.

When CTCSS or DCS is enabled on your radio, only signals that are using the same code as your radio will be heard in your speaker and the Squelch will remain closed to all other signals.

NOTE: Enabling CTCSS or DCS codes do not prevent others from hearing your transmission.





CTCSS/DCS tones are switched off by default. To use CTCSS/DCS you must first enable a suitable CTCSS/DCS code from the Menu (see Menu options for more details). CTCSS and DCS codes are both accessible from the CTCSS Menu.

CTCSS TONE SET COMPATIBILITY



The GME CTCSS tone set comprises a table of 50 tones made up of the standard CCIR-38 Tone Set plus an additional 12 tones added to the end. If communicating with other brands of radios that only use the CCIR-38 tone set, please select from one of the first 38 tones to ensure compatibility with these models.

IMPORTANT: If communicating with other GME radios, you may choose from any of the 50 tones. However, please refer to the tone set tables listed in each radio's Instruction manual for compatibility because, although the same 50 tones are available in all GME radios, the tones used in older GME models may be listed in a different order.

To enable a CTCSS or DCS code:

1. Press and hold the  key until the radio beeps.
2. Press the  key repeatedly until 'CTCOF' appears.
3. Press the  key to enable CTCSS and select a CTCSS code (CTC01 to CTC50).
4. Continue pressing the  past CTC50 to select a DCS code (DT001 to DT104).
5. Press the **PTT** to exit.

To disable a CTCSS or DCS code:

1. Press and hold the  key until the radio beeps.
2. Press the  key repeatedly until the current CTCSS (CTCXX) or DCS (DTXXX) tone setting appears (where the 'X' is a tone value).
3. Press the  key repeatedly until 'CTCOF' is displayed.
4. Press the **PTT** to exit.





To activate Silent mode on a channel

1. Select the required channel.
2. Press and hold the **Squelch** key. The display will show **S** (for CTCSS) or **S-** (for DCS).
3. Repeat steps 1 & 2 to activate silent mode on other channels.

Channels that have silent mode enabled will now stay silent unless a signal containing your chosen CTCSS or DCS code is received.

NOTE: You may activate CTCSS on any channels except the emergency channel 5/35.

To deactivate Silent mode on a channel

1. Select the required channel using the  or  keys. **S** (for CTCSS) or **S-** (for DCS) should be displayed on that channel.
2. Press and hold the **Squelch** key. **S** or **S-** will disappear from the display.



The channel will now be open to all incoming signals.

NOTE: Silent mode cannot be activated unless a CTCSS or DCS code has been selected via the Menu. If CTCSS/DCS tones are set to 'Off', any attempt to activate the Silent mode will be ignored.

MONITOR FUNCTION



When operating in Silent mode, the Monitor function opens the Squelch, allowing you to listen on the channel for signals that are not using your CTCSS/DCS code. In Silent mode, your Squelch would normally remain closed preventing these signals from being heard. By pressing the **Squelch** key, you can listen on the channel to check that it is clear before transmitting.

To use the Monitor function, briefly press the **Squelch** key. If no signals are present you will hear the background hiss of an empty channel. Press the **Squelch** key again to close the Squelch.

TIP: If you wish to identify a CTCSS code being used by other stations operating on your channel, first enable CTCSS on that channel (so that **S** or **S-** is displayed) then select the CTCSS setting function in the Menu. Use the  or  keys to step through the range of available CTCSS/DCS codes while the channel is busy. When the correct code is selected, the mute will open and you will be able to hear the signal in the speaker.

BUSY LOCKOUT



When using Silent mode with CTCSS/DCS, your radio's receiver remains quiet to all signals outside your CTCSS/DCS group. As a result, you may not notice when others are transmitting on your channel and you could accidentally transmit over the top of them.

The Busy Lockout function detects when others outside your CTCSS/DCS group are transmitting on the channel and prevents your radio from transmitting over them. If the channel is busy and you press the **PTT** the radio will emit a warning beep and the  icon won't be displayed. When you release the **PTT**, look for the  icon on the display and the green LED indicator on the panel as indicators that the channel is in use. If so, simply wait until the channel is clear and press the **PTT** again.

NOTE: You can also press the **Monitor/Squelch** key to open the Squelch and listen for signals on the channel before transmitting.

To enable Busy Lockout

1. Press and hold the  key until the radio beeps.
2. Press the  key repeatedly until 'BLKOF' appears.

3. Press the  key to enable Busy Lockout. 'BLKON' is displayed.
4. Press the  key to disable Busy Lockout. 'BLKOF' is displayed.
5. Press the **PTT** to exit.

CTCSS TONE FREQUENCIES

No.	Frequency	No.	Frequency	No.	Frequency	No.	Frequency
1	67.0	14	107.2	27	167.9	40	159.8
2	71.9	15	110.9	28	173.8	41	165.5
3	74.4	16	114.8	29	179.9	42	171.3
4	77.0	17	118.8	30	186.2	43	177.3
5	79.7	18	123.0	31	192.8	44	183.5
6	82.5	19	127.3	32	203.5	45	189.9
7	85.4	20	131.8	33	210.7	46	196.6
8	88.5	21	136.5	34	218.1	47	199.5
9	91.5	22	141.3	35	225.7	48	206.5
10	94.8	23	146.2	36	233.6	49	229.1
11	97.4	24	151.4	37	241.8	50	254.1
12	100.0	25	156.7	38	250.3	–	–
13	103.5	26	162.2	39	69.4	–	–

DSC TONE CHART

DCS	CODE	DCS	CODE	DCS	CODE	DCS	CODE	DCS	CODE	DCS	CODE
1	023	19	116	37	225	55	325	73	452	91	627
2	025	20	122	38	226	56	331	74	454	92	631
3	026	21	125	39	243	57	332	75	455	93	632
4	031	22	131	40	244	58	343	76	462	94	654
5	032	23	132	41	245	59	346	77	464	95	662
6	036	24	134	42	246	60	351	78	465	96	664
7	043	25	143	43	251	61	356	79	466	97	703
8	047	26	145	44	252	62	364	80	503	98	712
9	051	27	152	45	255	63	365	81	506	99	723
10	053	28	155	46	261	64	371	82	516	100	731
11	054	29	156	47	263	65	411	83	523	101	732
12	065	30	162	48	265	66	412	84	526	102	734
13	071	31	165	49	266	67	413	85	532	103	743
14	072	32	172	50	271	68	423	86	546	104	754
15	073	33	174	51	274	69	431	87	565	-	-
16	074	34	205	52	306	70	432	88	606		
17	114	35	212	53	311	71	445	89	612	-	-
18	115	36	223	54	315	72	446	90	624	-	-





RECEIVE (RX) ONLY CHANNELS

The TX6500S supports up to 95 user programmable Receive-only channels with frequencies in the range 403 – 520 MHz. Frequencies can be stored in 5 separate channel banks labelled A to E, each containing up to 19 channels. These additional 19 channels are located directly above CB channel 80 (81 – 99). Each Receive-only channel can also be assigned an Alpha label to help identify that channel when it is selected. Frequency programming and channel bank selections are accessed through the configuration Menu.

Selecting channel banks

Before programming or recalling channels you should select the required channel bank. The 5 channel banks can be enabled through the Menu either as individual banks of 19 channels (RX-A, RX-B, RX-C, RX-D or RX-E) or as a combined group of 95 channels (RXA-E). The default channel bank is RX-A.

To select any channel bank

1. Press and hold the  key until a high beep will be heard.
2. Press the  key repeatedly until 'RX-x' is displayed where 'x' is a channel bank labelled A, B, C, D or E.
3. Press the  key to step upwards through the channel banks. Select RX-A through RX-E to enable one of the 5 single channel banks of 19 channels. Select RXA-E to enable all channel banks as a combined group of 95 channels.
4. Press the  key to step back downwards through the channel banks.
5. When finished, press the **PTT** to exit the Menu.

Using channel banks

When using individual channel banks RX-A to RX-E, each channel bank is enabled separately to provide 19 channels of Receive-only frequencies in each bank. Channels are numbered from 81 to 99.

SEPARATE CHANNEL BANK

	RX-A	RX-B	RX-C	RX-D	RX-E
RX ONLY CHANNELS	81	81	81	81	81
	82	82	82	82	82
	83	83	83	83	83
	84	84	84	84	84
	85	85	85	85	85
	86	86	86	86	86
	87	87	87	87	87
	88	88	88	88	88
	89	89	89	89	89
	90	90	90	90	90
	91	91	91	91	91
	92	92	92	92	92
	93	93	93	93	93
	94	94	94	94	94
	95	95	95	95	95
	96	96	96	96	96
	97	97	97	97	97
	98	98	98	98	98
	99	99	99	99	99

When using the combined channel bank RXA-E, all 5 channel banks becomes available in one continuous sequence resulting in a total of 95 channels of Receive-only frequencies. Channels are numbered in a repeating sequence from 81 – 99.

COMBINED CHANNEL BANKS RXA-E

	RX-A	RX-B	RX-C	RX-D	RX-E
81	81	81	81	81	81
82	82	82	82	82	82
83	83	83	83	83	83
84	84	84	84	84	84
85	85	85	85	85	85
86	86	86	86	86	86
87	87	87	87	87	87
88	88	88	88	88	88
89	89	89	89	89	89
90	90	90	90	90	90
91	91	91	91	91	91
92	92	92	92	92	92
93	93	93	93	93	93
94	94	94	94	94	94
95	95	95	95	95	95
96	96	96	96	96	96
97	97	97	97	97	97
98	98	98	98	98	98
99	99	99	99	99	99

The diagram shows a vertical column of orange boxes labeled 'RX ONLY CHANNELS' on the left, with numbers 81 through 99. To the right, there are five columns labeled RX-A through RX-E, each containing the same numbers 81 through 99. Curved arrows connect the top of each RX-A column to the top of the next (RX-B, RX-C, RX-D, RX-E), and similar arrows connect the bottom of each column to the bottom of the next, indicating a continuous sequence across all banks.

CHANNEL EDITOR

Receive-only channels are switched off by default. To enable them you will need to activate the channel editor in your radio which will then allow access to programming frequencies into channels 81-99 of your selected channel bank. Receive-only channels can be programmed with frequencies in the range 403 – 520 MHz.

To Activate the channel editor

1. Switch the radio off.
2. Press and hold the  key while switching the radio on again.
3. 'RXALL' will be displayed briefly, indicating the RX Channel Editor has been activated.

You can now use the  or  keys to select channels 81 – 99 for programming.

Frequency steps

When selecting frequencies, your radio will use 12.5 kHz steps, however the display will only show the frequency to the nearest 10 kHz. See the table over page.

e.g. 468.4250 MHz will display as:

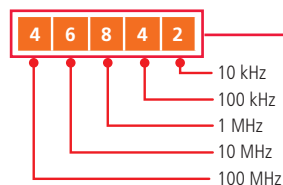

Display	Frequency
46840	468.4000
46841	468.4125
46842	468.4250
46843	468.4375
46845	468.4500
46846	468.4625
46847	468.4750
46848	468.4875
46850	468.5000

Programming receive-only frequencies

While in the channel editor:

1. Press the \uparrow or \downarrow keys to select a suitable channel (81-99).
2. Press and hold the MENU key until the radio beeps. 'OFF-' will flash under the channel number. You now have 20 seconds to begin programming otherwise the Menu will time-out.
3. Press the \uparrow key to begin selecting the desired frequency starting at 403 MHz. The right hand digit will flash. Press the \uparrow key repeatedly to increase the frequency in 12.5 kHz steps (the display will show the frequency to the nearest 10 kHz). Press the \downarrow key to decrease the frequency. To advance more quickly through the frequencies, press and hold the \uparrow or \downarrow keys.
4. To change the frequency in 1 MHz steps, briefly press the CALL LOCK key. The 1 MHz digit will flash. Now press the \uparrow or \downarrow keys to adjust the frequency in 1 MHz steps.
As you approach the desired frequency, briefly press the CALL LOCK key again to return the original 12.5 kHz steps for finer adjustment.
5. When the desired frequency is displayed, press and hold the CALL LOCK key to store it. The frequency will flash then the radio will beep. The radio will then exit the Menu and return to normal operation.
6. Repeat steps 1 – 5 to program other channels.

NOTE: The frequency tuning is live which means the radio is actually listening to the frequencies you are selecting. You can use this feature to locate and store active frequencies while you are tuning.

If you need to program more than 19 channels, simply select another channel bank.

To close the channel editor

Once you have finished programming your frequencies, switch the radio Off then On again. Normal operation will be restored and only those Receive-only channels you have programmed will be selectable above channel 80. Remember, if you have programmed some of your channels into different channel banks, you will need to select the appropriate channel bank to access them.

Displaying Alpha names on your Receive-only channels

By default the TX6500S displays the received signal strength under the channel number on all channels. However on Receive-only channels you can also configure the display to show an Alpha name or the channel frequency. This option is only available when a receive-only channel is selected.

1. Select a receive-only channel.
2. Press and hold the MENU key until the radio beeps.
3. Briefly press the MENU key repeatedly to advance to the S-Meter option. ('S-MET', 'S-LIN' or 'BATT' will be displayed. 'S-MET' is the default).

4. Press the  key repeatedly until 'ALPHA' is displayed.

5. Press the **PTT** to exit the Menu.

The channel will now display the channel frequency or an Alpha name (depending on whether your radio is in Alpha mode).

To switch between Alpha and Frequency modes

1. Select a receive-only channel.

2. Press and hold the  key until the radio beeps. A character will flash on the displayed Alpha label or frequency.

3. Briefly press the **Squelch** key to toggle between Alpha and Frequency modes.

4. Press the **PTT** to exit.

NOTE: If you have not previously set an Alpha name, a default Alpha name comprising the channel bank and the channel number will be displayed. e.g. RXA99

To edit the Alpha label

1. Press and hold the  key until the radio beeps.

2. If required, briefly press the **Squelch** key to select the Alpha mode. The left hand character should be flashing.

3. Press the  or  keys to change the character in the flashing position.

4. Press the  key to select the next character position.

5. Repeat steps 3 & 4 to edit each character.

6. When finished, press the **PTT** to store the new label.



To delete a Receive-only channel

NOTE: You do not need to enable the channel editor to delete Receive-only channels.

1. Use the  or  keys to select the Receive-only channel.

2. Press and hold the  key until the radio beeps.

3. If required, briefly press the **Squelch** key to select the frequency mode. The right hand digit should be flashing.

4. Briefly press the  key to select the 1 MHz digit (this will allow faster frequency stepping) then press the  key repeatedly until '-OFF-' is displayed.

5. Press the **PTT** store the new setting.

The deleted channel will no longer be visible in normal operating mode.



To edit the frequency of a Receive-only channel

NOTE: You do not need to enable the channel editor to edit a current Receive-only channel.

1. Use the  or  keys to select the Receive-only channel you wish to edit.

2. Press and hold the  key until the radio beeps.



3. If required, briefly press the **Squelch** key to select the frequency mode. The right hand digit should be flashing.

4. Press the  or  keys to change the frequency. To change the frequency in 1 MHz steps, briefly press the  key.

5. When the new frequency has been selected, press the **PTT** store it.

Scanning on Receive-only channels

Receive-only channels can be programmed into your Open or Group scan groups in the same way as your normal CB channels. Receive-only channels cannot be programmed into your Network scan group.

To add receive-only channel to your scan group, simply select the required scan group (Open or Group), select the receive-only channel then press and hold the  key until the radio beeps.  will be displayed on that channel. For more details on scanning, see the section on 'Scanning' in this manual.

SIGNAL METER DISPLAY

The signal meter display is factory set to display the signal strength of the incoming signal. However it can also be set to display other options. The following options are available.





On CB channels:

- S-MET: Incoming signal levels are displayed in the Signal Meter area. The S-Meter displays signal strengths in the standard logarithmic measurement.
- S-LIN: Incoming signal levels are displayed in the Signal Meter area. The S-Meter displays signal strengths as a linear measurement.
- BATT: The battery charge level is displayed in Volts in the Signal Meter area.





On Receive-only channels:

- S-MET: Incoming signal levels are displayed in the Signal Meter area. The S-Meter displays signal strengths in the standard logarithmic measurement.
- S-LIN: Incoming signal levels are displayed in the Signal Meter area. The S-Meter displays signal strengths as a linear measurement.
- BATT: The battery charge level is displayed in Volts in the Signal Meter area.
- ALPHA – Displays the receive-only channel frequency or Alpha label in the Signal Meter area when receive-only channels are selected.

To change the signal meter display:

1. Press and hold the  key until the radio beeps.
2. Press the  key repeatedly until 'S-MET' appears.
3. Press the  key to select from 'S-MET', 'S-LIN', 'BATT' or 'ALPHA' (only on receive-only channels).
4. Press the  key repeatedly to return to the default 'S-MET' option.
5. Press the PTT to exit.

To access the Menu

- Press and HOLD the  key until the radio beeps. The Menu will be activated and the first Menu item will be displayed.
- Press the  or  keys to change the settings in the current Menu item.
- Press the  key to step to the next Menu item. Any changes to the current Menu item will be stored.
- To exit the Menu, press the PTT (or press and HOLD the  key).

While in the Menu, if no keys are pressed within 20 seconds the Menu will time out and the radio will return to normal operation.

NOTE: When you change a Menu setting, the new setting becomes available immediately.

MENU FUNCTIONS

The TX6500S Menu feature provides a convenient method of customising some of the radio's functions. The follow parameters are available.

Menu Item	Settings	Description	CB Ch	RX-Only Channels
Frequency/ Alpha Label Editing	e.g '43529'	Channel Frequency Edit	N/A	•
	e.g 'CAR 1'	Channel Alpha Label Edit	N/A	•
Squelch	SQL-1 -> SQL-9	Squelch sensitivity	•	•
CTCSS/DCS	CTCOF	CTCSS Off	•	•
	CTC01 -> CTC50	CTCSS Codes 1-50	•	•
	DT001 -> DT104	DTS Codes 001 -104	•	•
Network Scan CTCSS/DCS	NS-OF	Network Scan Off	•	•
	NS-01 -> NS-50	Network Scan CTCSS Codes 1-50	•	•
	NS001 -> NS104	Network Scan DTS Codes 001 -104	•	•
Scrambler	ENCOF	Scrambler encoder Off	•	•
	ENCON	Scrambler encoder On	•	•
Silent Squelch Tail	SSTOF	Silent Squelch Tail Off	•	•
	SSTON	Silent Squelch Tail On	•	•
Key Beeps	BEEP0 -> BEEP9	Keypad beeps 0 (off) to 9 (max)	•	•
Dynamic Volume Control	DVCOF	Dynamic Volume Control Off	•	•
	DVCON	Dynamic Volume Control On	•	•
S-Meter/ Battery Display	S-MET	Standard S-Meter	•	•
	S-LIN	Linear S-Meter	•	•
	BATT	Battery Voltage	•	•
	APLHA	Alpha Labels on Channels	N/A	•
Busy Lockout	BLKOF	Busy Lockout Off	•	•
	BLKON	Bust Lockout On	•	•
Volume Minimum	VMIN0 -> VMIN8	Minimum Volume 0 (min) to 8 (max)	•	•
Display Contrast	CONT1 -> CONT9	Display Contrast	•	•
RX-only Channel Banks	RX-A	RX-only Channel Bank A	•	•
	RX-B	RX-only Channel Bank B	•	•
	RX-C	RX-only Channel Bank C	•	•
	RX-D	RX-only Channel Bank D	•	•
	RX-E	RX-only Channel Bank E	•	•
	RXA-E	RX-only Channel Banks A -> E	•	•

CONSERVING YOUR BATTERY POWER

The TX6500S has built in power saving features to help you get the maximum amount of time between charges from your Li-ion battery pack. If you need to operate your TX6500S in a situation where you require maximum battery life (e.g. a remote site where there is no convenient recharging facility nearby), the following hints can greatly reduce the amount of power drawn from the battery pack.

Sleep mode

The TX6500S will automatically enter the 'Sleep' mode after around 20 seconds of inactivity (i.e. no transmission or reception). While sleeping, it will still check for incoming signals but it will draw only about one fifth of the power from the battery. As soon as a signal is received or any keys are pressed, the TX6500S will wake up again. This sleep function is automatic and by itself can greatly extend the battery life in standby mode by many hours.

Quiet mode

If 'Quiet' mode is selected, the TX6500S will remain 'asleep' on Quiet channels even if they are busy unless your SelCall Ident is received.

Scanning

The TX6500S draws more power from the battery when scanning than when monitoring a single channel. This is because it must wake more often to monitor each channel for activity. You can squeeze that extra bit of life from the battery by avoiding any unnecessary scanning. In addition, scanning several channels increases the chance of finding a signal thereby keeping the receiver awake and the Squelch open more often.

Low Transmit power setting

The transmitter has both High and Low power settings. If you are only operating over short distances, are in a reasonably high location or are close to a local repeater, try using the LOW transmit power setting. This reduces the transmitter power from 5 Watts to 1 Watt, effectively tripling the 'talk' time available.

General

Continuously monitoring a busy channel will reduce the battery life because incoming signals will keep the receiver awake and the Squelch will stay open for longer periods of time. This will draw much more power from the battery pack. If you are expecting to receive a SelCall on a busy channel, program that channel for 'Quiet' operation and select the Quiet mode. The TX6500S will then stay 'asleep' until your SelCall Ident is received.

UHF CB OPERATING FREQUENCIES

CH	Frequency (MHz)	CH	Frequency (MHz)	CH	Frequency (MHz)	CH	Frequency (MHz)
1	476.425	21	476.925	41	476.4375	61	476.9375
2	476.450	22	476.950	42	476.4625	62	476.9625
3	476.475	23	476.975	43	476.4875	63	476.9875
4	476.500	24	477.000	44	476.5125	64	477.0125
5	476.525	25	477.025	45	476.5375	65	477.0375
6	476.550	26	477.050	46	476.5625	66	477.0625
7	476.575	27	477.075	47	476.5875	67	477.0875
8	476.600	28	477.100	48	476.6125	68	477.1125
9	476.625	29	477.125	49	476.6375	69	477.1375
10	476.650	30	477.150	50	476.6625	70	477.1625
11	476.675	31	477.175	51	476.6875	71	477.1875
12	476.700	32	477.200	52	476.7125	72	477.2125
13	476.725	33	477.225	53	476.7375	73	477.2375
14	476.750	34	477.250	54	476.7625	74	477.2625
15	476.775	35	477.275	55	476.7875	75	477.2875
16	476.800	36	477.300	56	476.8125	76	477.3125
17	476.825	37	477.325	57	476.8375	77	477.3375
18	476.850	38	477.350	58	476.8625	78	477.3625
19	476.875	39	477.375	59	476.8875	79	477.3875
20	476.900	40	477.400	60	476.9125	80	477.4125

	Emergency use only
	Telemetry / SelCall use only. Voice transmission is inhibited as required by AS/NZS 4365.2011
	Guard band channel. Transmission is inhibited as required by AS/NZS 4365.2011
	Repeater input channels (Duplex)
	Repeater output channels (Duplex)
11	Officially designated call channel
40	Road channel
18	Caravan and motorhome
10	4WD / Offroad

SPECIFICATIONS

GENERAL

Compliance:	Compliant with AS/NZS 4365 for radio communications equipment in the UHF citizen band and personal radio service.
Frequency Range:	476.425 MHz – 477.4125 MHz
Number of Channels:	80 (plus 95 receive only)
Tuneable Frequency Range (receive only):	403 MHz – 520 MHz
Channel Spacing:	12.5 kHz
Operating Mode:	Simplex or half duplex
Scanning Speed:	40 ms per channel (25 channels per second)
Antenna Impedance:	50 Ohms nominal
Battery Voltage:	7.4 volts DC nominal
Operating Voltage Range:	6 – 9 volts DC
Low Battery Alarm:	6.9 volts DC
Reverse Voltage Protection:	Shunt Diode
Operating Temperature:	-20° C to +60° C
Frequency Stability:	± 2.5 PPM
Modulation:	FM

TRANSMITTER

RF Output:	High: 5 watts Low: 1 watt
Conducted Spurious Emission:	< -75 dBm
Maximum Deviation:	< ± 2.5 kHz at + 20 dB limiting
Transmit Frequency Response:	+6 dB per octave 300 Hz to 3 kHz, + 1, -3 dB
Current Consumption (max):	2.0 amps typical

RECEIVER

Sensitivity (450 – 520 MHz):	-121 dBm for 12 dB SINAD
Intermediate Frequencies:	1st: 38.85 MHz 2nd: 450 kHz
Adjacent Channel Selectivity:	>65 dB
Intermodulation Immunity:	>65 dB
Blocking Immunity:	>90 dB
Spurious Response Immunity:	>70 dB
Image Rejection:	>60 dB
Audio Output Power:	1 watt at <10% distortion
Audio Signal to Noise:	> 40 dB
Receiver Frequency Response:	-6 dB per octave de-emphasis, 300 Hz to 3 kHz, + 1, -3 dB
Squelch:	SQL-1: -122 dBm typical SQL-9: -110 dBm typical
Current Consumption:	40 mA sleep mode 80 mA muted 340 mA full volume

MECHANICAL

Dimensions:	60 mm (W) x 40 mm (D) x 130 mm (H) (not including antenna)
Weight:	340 grams
Antenna:	TNC female
Speaker/Microphone/Programming:	8 pin connector
Battery Rapid Charging:	4 plated terminals with temperature sensor

.....
NOTE: All values are typical unless otherwise stated and are subject to change without notice or obligation.
.....

STANDARD COMMUNICATIONS WARRANTY AGAINST DEFECTS

This warranty against defects is given by Standard Communications Pty Ltd ACN 000 346 814 (We, us, our or GME). Our contact details are set out in clause 2.7. This warranty statement only applies to products purchased in Australia. Please contact your local GME distributor for products sold outside of Australia. Local distributor details at www.gme.net.au/export.

1. Consumer guarantees

- 1.1 Our goods come with guarantees that cannot be excluded under the Australian Consumer Law. You are entitled to a replacement or refund for a major failure and for compensation for any other reasonably foreseeable loss or damage. You are also entitled to have the goods repaired or replaced if the goods fail to be of acceptable quality and the failure does not amount to a major failure.
- 1.2 To the extent we are able, we exclude all other conditions, warranties and obligations which would otherwise be implied.

2. Warranty against defects

- 2.1 This warranty is in addition to and does not limit, exclude or restrict your rights under the Competition and Consumer Act 2010 (Australia) or any other mandatory protection laws that may apply.
- 2.2 We warrant our goods to be free from defects in materials and workmanship for the warranty period (see warranty table) from the date of original sale (or another period we agree to in writing). Subject to our obligations under clause 1.2, we will at our option, either repair or replace goods which we are satisfied are defective. We warrant any replacement parts for the remainder of the period of warranty for the goods into which they are incorporated.
- 2.3 To the extent permitted by law, our sole liability for breach of a condition, warranty or other obligation implied by law is limited
 - (a) in the case of goods we supply, to any one of the following as we decide -
 - (i) the replacement of the goods or the supply of equivalent goods;
 - (ii) the repair of the goods;
 - (iii) the cost of repairing the goods or of acquiring equivalent goods;
 - (b) in the case of services we supply, to any one of the following as we decide –
 - (i) the supplying of the services again;
 - (ii) the cost of having the services supplied again.
- 2.4 For repairs outside the warranty period, we warrant our repairs to be free from defects in materials and workmanship for three months from the date of the original repair. We agree to re-repair or replace (at our option) any materials or workmanship which we are satisfied are defective.
- 2.5 We warrant that we will perform services with reasonable care and skill and agree to investigate any complaint regarding our services made in good faith. If we are satisfied that the complaint is justified, and as our sole liability to you under this warranty (to the extent permitted at law), we agree to supply those services again at no extra charge to you.
- 2.6 To make a warranty claim you must before the end of the applicable warranty period (see warranty table), at your own cost, return the goods you allege are defective, provide written details of the defect, and give us an original or copy of the sales invoice or some other evidence showing details of the transaction.
- 2.7 Send your claim to:
Standard Communications Pty Ltd.
PO Box 96 Winston Hills, NSW 2153, Australia.
Tel: (02) 8867 6000 Fax: (02) 8867 6199
Email: servadmin@gme.net.au
- 2.8 If we determine that your goods are defective, we will pay for the cost of returning the repaired or replaced goods to you, and reimburse you for your reasonable expenses of sending your warranty claim to us.

3. What this warranty does not cover

3.1 This warranty will not apply in relation to:

- (a) goods modified or altered in any way;
- (b) defects and damage caused by use with non Standard Communications products;
- (c) repairs performed other than by our authorised representative;
- (d) defects or damage resulting from misuse, accident, impact or neglect;
- (e) goods improperly installed or used in a manner contrary to the relevant instruction manual; or
- (f) goods where the serial number has been removed or made illegal.

4. Warranty period

4.1 We provide the following warranty on GME and Kingray products. No repair or replacement during the warranty period will renew or extend the warranty period past the period from original date of purchase.

PRODUCT TYPE	WARRANTY PERIOD
477 MHz UHF CB handheld radios	3 years
Li-Ion battery packs	1 year

For more information call or visit us:

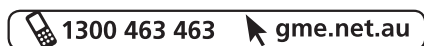

A division of Standard Communications Pty. Ltd.

Head Office: PO Box 96, Winston Hills, NSW 2153, Australia.

New Zealand: PO Box 58, 446 Botany, Auckland, 2163, NZ. T: (09) 274 0955.

All other international enquiries email: **export@gme.net.au**

Part Number: 310511 Drawing Number: 45315-1