



# GP450X

INNOVATIVE ELECTRONICS | COMMUNICATION | SAFETY | ENTERTAINMENT

## Marine GPS Plotter

- > Compact and accurate
- > 4.5" monochrome silver bright LCD
- > Screen pixel resolution 240w x 160h
- > 999 available waypoints, 50 routes with 30 waypoints per route.
- > NMEA 0183 output interface
- > Custom nav data displays
- > Plotter scale range 0.02-320 nm
- > Multiple language options

The GP450X is a feature packed yet compact stand alone GPS navigator with a 12 parallel channel receiver with SBAS (Satellite-Based Augmentation Systems) support. The GPS processor within the GP450X is able to perform high speed processing giving you fast position updating.

The GP450X is a cost effective solution for a compact, full featured plotter suitable for any coastal, fishing or pleasure craft.

Containing a wide range of navigational pages including plotter, highway, steering, compass, large digit Lat/Lon and custom data displays allowing easy navigation to all your favourite destinations.

The user friendly software and easy to read display make the GP450X system a must for boaters with simplicity in mind, but big plotter features.



# GP450X Specifications



## GPS/SBAS

Receiver type: GPS: 12 channels, C/A code, all-in-view. SBAS receiver.

Receiver frequency: L1 (1575.42 MHz)

Time to first fix: 15 seconds average (hot start)

Tracking velocity: 999 knots

Geodetic system: WGS-84

## Accuracy

GPS: 15 m (49.2 ft)

SBAS: 3 m (9.8 ft)

## Display

Dimensions: 4.5" diagonal, 95 (w) x 63 (h) mm LCD - 240 x 160 pixels.

Display modes: Plotter, highway, steering, compass, speedometer, nav data, 2 pages for custom display.

## General

Memory capacity: 2,500 ship's track points  
999 waypoints with comments  
50 routes, 30 waypoints per route.

Alarms: Arrival, anchor watch, XTE, speed, time, trip, odometer.

Language: English, Spanish, Italian, Chinese, French.

Interface: Output (NMEA0183 ver 2.0)  
AAM, APB, BOD, BWC, GGA, GLL, RMB, RMC, VTG, XTE, ZDA.

Power supply: 12-24 V DC, 240-120 mA.

## Environment

Temperature: Display unit: -15°C to +55°C  
(5°F to +131°F)

Antenna unit: -25°C to +70°C  
(-13°F to +158°F)

Waterproofing: Display unit: IPX5  
Antenna unit: IPX6

## In the box

Display unit with SBAS receiver  
Antenna unit AEG001  
Connecting cables  
Mounting bracket with gimbals  
Cabin cover  
Instruction manual

\*Specifications are typical unless otherwise indicated and may be subject to change without notice or obligation.

## Unit measurements (mm)

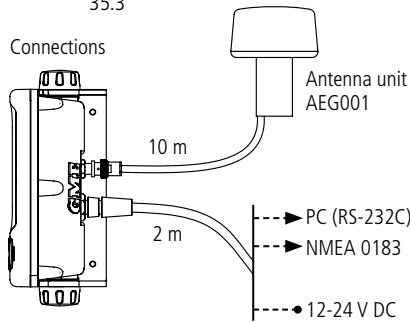
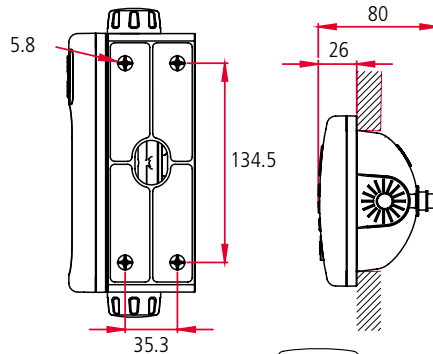
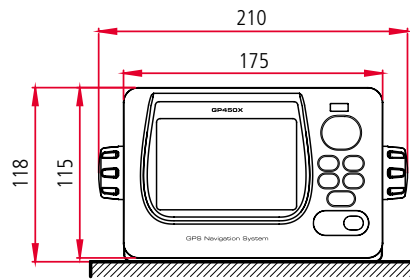

## SBAS - Satellite Based Augmentation Systems

An SBAS provider sends GPS signal corrections to SBAS users to increase accuracy to typically less than 3 meters. SBAS worldwide providers are; WAAS available in North America, MSAS (Multi-Functional Satellite Augmentation System) available in Japan and EGNOS (Euro Geostationary navigation Overlay Service) available in Europe. All providers are compatible with each other allowing 'seamless' position fixes to SBAS users.

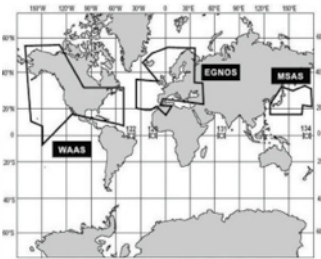

Major contributors of an error in a single frequency GPS system are a receiver clock drift and signal delays by refraction. The SBAS reference stations on the earth monitor the GPS constellation and route GPS error data to the SBAS satellite via the master earth station. The Inmarsat or communication satellite broadcasts the differential corrections to users.

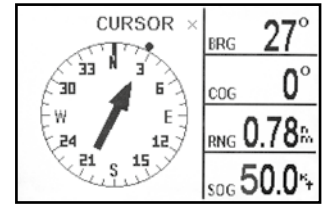

## Compass

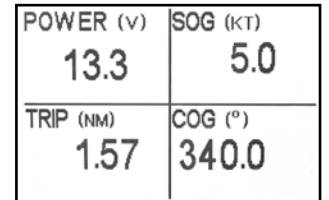

## Custom display

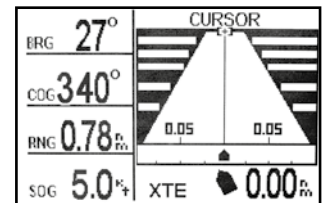

## Highway

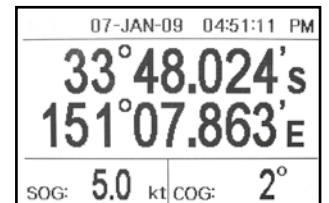

## Lat/Lon

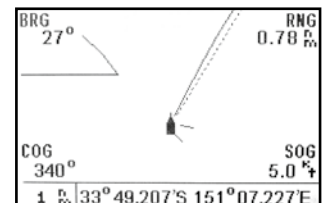

## Plotter

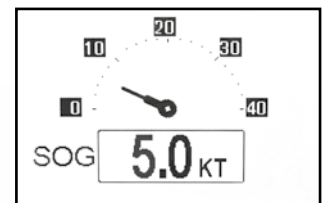

## Speedometer

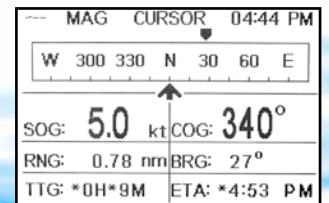

## Steering

retailer:

1300 463 463 [gme.net.au](http://gme.net.au)

A division of Standard Communications Pty Ltd.

Head Office: PO Box 96, Winston Hills, NSW 2153, Australia.

New Zealand: PO Box 58, 446 Botany, Auckland 2163 T: (09) 274 0955

All other international enquiries email: [export@gme.net.au](mailto:export@gme.net.au)

